

**BY2677 Digital  
Insulation Resistance Tester**



# CONTENTS

I Safety information.....	- 2 -
II Product Features.....	- 4 -
III Technique Indications.....	- 5 -
IV Meter Layout.....	- 7 -
V Key Functions.....	- 9 -
VI Measurement Operation.....	- 12 -
VII Measurement.....	- 13 -
VIII Replacing The Battery.....	- 18 -
IX How to use power adaptor.....	- 19 -

## I Safety information

This meter complies with IEC61010 safety measurement requirement.

### **Warning**

- Please read and understand this instruction manual carefully before using the instrument.
- whenever necessary, obey the requirements of the manuals and keep the manuals well for reference
- When the instrument is tested, the wrong operation will lead to accidents and instrument damage.
-  on this instrument means for safely purpose users should refer to relevant parts of the manual.

 **Danger** identifies conditions and actions that pose hazards to the user.

 **Warning** alerts the user to avoid electric shock.

 **Caution** identifies conditions or actions that may damage the meter and affect measurement.

### **Danger**

- Do not apply more than 600V.
- Do not use the meter around explosive gas, vapor or dust.
- When using the test leads, keep your fingers away from the lead contacts.
- Keep your finger behind the finger guards on the leads.
- Do not use the meter with any parts or cover removed.
- When carrying out insulation measurement, do not contact the circuit under test.

---

 **Warning**





- Do not use the meter if it is damaged or metal part is exposed. Look for cracks or missing part.
- Be carefully when working above 33Vrms, 46.7Vac rms or 70Vdc. Such voltage may cause an electric shock.
- discharge all loading of the circuit under test after measuring high voltage
- Do not charge battery when it is placed in wet condition.
- Place test leads in proper input terminals, make sure all leads are firmly connected to the input terminals
- When opening the battery cover, ensure that the instrument has been turned off.

 **Caution**

- when performing resistance tests, remove all power from the circuit to be measured and discharge all the power.
- when serving the meter, use only the test leads and power adaptor with the same model or identical electrical specifications.
- Do not use the meter if the battery indicator  shows a battery empty condition. Take the battery out from the meter if it is not used for a long time.
- Do no use or store the meter in an environment of high temperature, humidity, explosive, inflammable and strong magnetic field. The performance of the Meter may deteriorate after dampended.
- Soft cloth and mild detergent should be used to clean the surface of the

Meter when servicing. No abrasive and solvent should be used to prevent the surface of the meter from corrosion, damage and accident

- Dry the meter before storing if it is wet

	Risk of electric shock
	Equipment protected by double or reinforced insulation
	DC measurement
	AC measurement
	Grounding

## II Product Features

1. Strictly follow IEC61010 safety standard, comply with safety standard of CAT III 600V and pollution level II.
2. Automatic voltage release function.
3. Backlit for easy work in dark light.
4. bar charts showings the measurement results.
5. High Voltage prompt and red warning light.
6. Auto shutdown when no operation for 15 minutes after measurement, press ON/OFF for one second to start
7. 18 sets of data storage capacity
8. Time setting function: auto execute the measurement in 15 minutes of the designated time.
9. COMP measurement (comparative functional measurement)
10. PI measurement (polarization index measurement)

11. Auto measuring resistance ratio can be set in any time duration in PI measurement.

### III Technique Indications

1. Error limit:  $\pm$  ([% of reading]+[number of least significant digits]).
2. Ambient temperature: 18~28°C
3. Environmental humidity: 45 ~ 75%RH
4. < insulation resistance test >

Rated voltage	500V	1000V	2500V	5000V
Measuring range	0.5MΩ~20GΩ	2MΩ~40GΩ	5MΩ~100GΩ	10MΩ~1000GΩ
Open circuit voltage	DC500V 0%~+20%	DC1000V 0%~+20%	DC2500V 0%~+20%	DC5000V 0%~+20%
Test current	500KΩ load: 1mA~1.2mA	1MΩ load: 1mA~1.2mA	2.5MΩ load: 1mA~1.2mA	5MΩ load: 1mA~1.2mA
Accuracy	0.0MΩ~99.9MΩ: ±(3%+5) 100MΩ~9.99GΩ :±(5%+5) 10.0GΩ~20.0G Ω:±(10%+5)	0.0MΩ~99.9MΩ: ±(3%+5) 100MΩ~9.99GΩ :±(5%+5) 10.0GΩ~40.0G Ω:±(10%+5)	0.0MΩ~99.9MΩ: ±(3%+5) 100MΩ~9.99GΩ :±(5%+5) 10.0GΩ~100GΩ :±(10%+5)	0.0MΩ~99.9MΩ: ±(3%+5) 100MΩ~9.99GΩ :±(5%+5) 10.0GΩ~99.9G Ω:±(10%+5) Above 100GΩ:±(20%+ 5) Humidity:Below 50%
Short circuit	maximum than 2.0mA			

#### Caution

Under any rated voltage, when measured resistance is less than 10MΩ, continuous measurement should not exceed 10 seconds.

#### 5. <Voltage Measurement>



	DC Voltage	AC Voltage
Measuring range	$\pm 30 \sim \pm 600V$	30~600V(50/60Hz)
resolution	1V	
Accuracy	$\pm(2\%+5)$ 30~100V (50/60Hz) $\pm(2\%+8)$	

6. Display: liquid crystal display, the maximum reading is 9999.
7. Low battery warning: Battery diagram (4 grids) (see Table 1).
8. overrun instruction: "OL"mark appears in the range of insulation resistance.
9. Automatic ranging function
10. Unit display: function, symbol display.
11. Working conditions: 0 ~ 40°C / Rh 85% or less.
12. Storage conditions: -20°C to 60°C / Rh 90% or less.
13. Dimension: 202mm (L) X155mm (W) X94mm (D)
14. Weight: 2kg (containing batteries)
15. Current consumption: about 1.1A (max) (usually at 20mA).
16. Accessories:
  - 1) test line
  - 2) Battery 1.5V (LR14) × 8 pcs
  - 3) Instruction manual
  - 4) Carrying box
  - 5) Special power adapter (input voltage 230V, 50/60Hz, 100mA, output DC14V, 1.3A).

 Caution

Use our company dedicated power adapter, otherwise there will be danger.

## IV Meter Layout

### 1. Front

1	LCD	2	Arrow button
3	Emergency stop	4	Data clear the display backlight button
5	▼Arrow button	6	On/off button
7	Compare button	8	Insulation measurement button
9	DC voltage measurement button	10	Timer button
11	AC voltage measurement button	12	Test button
13	USB button	14	Data store button
15	Data recall button	16	Arrow button
17	▲Arrow button	18	LINE:HV input terminal (connected to two-plug red test lead)
19	High voltage line shielding input terminal ( connected to two-plug red test lead)	20	GUARD:grounding protection input terminal (connected to one-plug black test lead)
21	EARTH: High resistance measurement input terminal ( connected to one-plug test lead)	22	Testing leads: Two-plug red test lead to one alligator clip One-plug black test lead to one alligator clip One-plug green test lead to one alligator clip



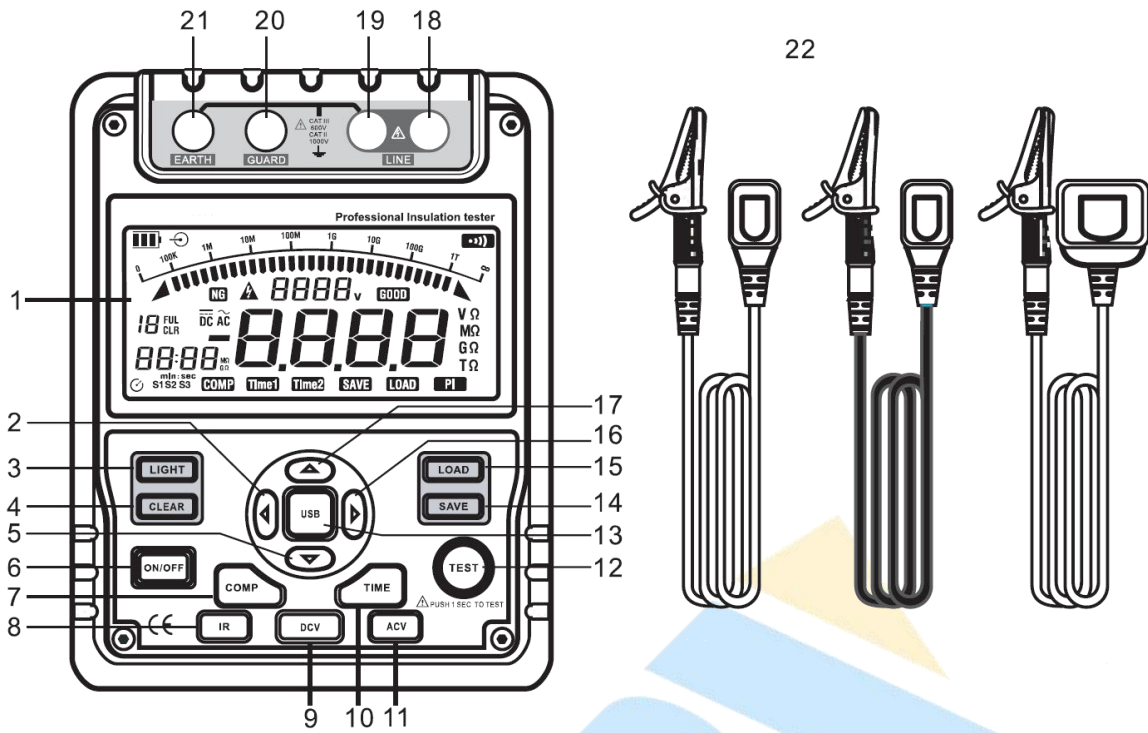

Figure 1

## 2. The Meter Side Structure

1	Safety Shutter
2	Power Adaptor Input Terminal

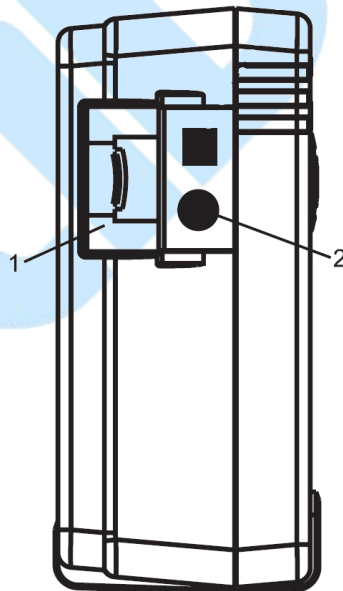

Figure 2

## 3. Display

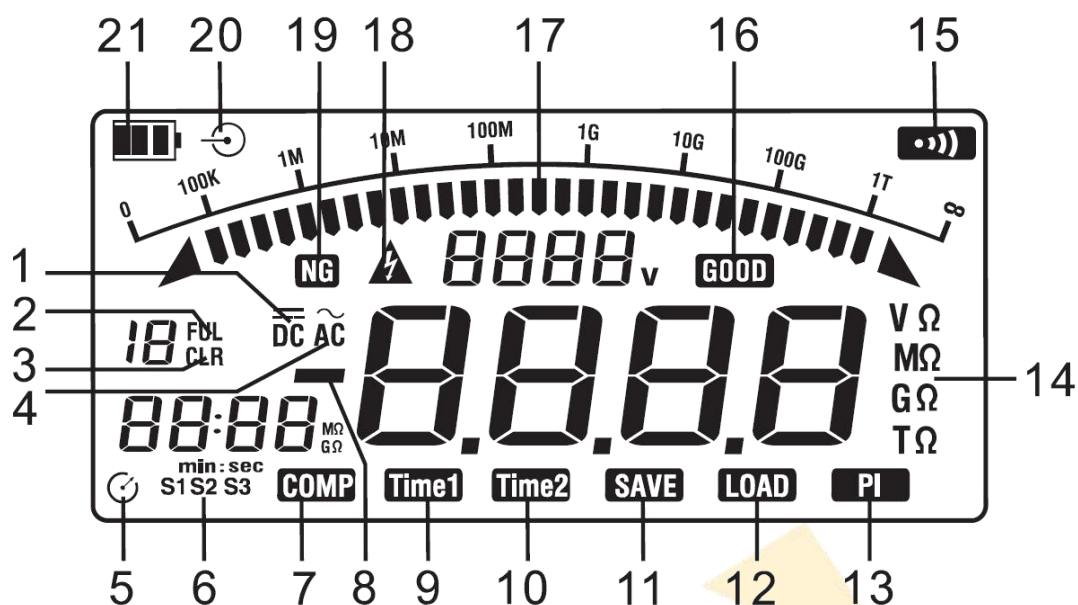

Figure 3

1	Indicator For DC Voltage	2	Indicator For Data Store Full
3	Indicator For Clearing	4	Indicator For AC Voltage
5	Indicator for timer	6	Step symbol
7	Indicates selected pass/fail compare value	8	Indicates for negative reading
9	Timer 1 symbol	10	Timer 2 symbol
11	Data store is on	12	Data recall is on
13	Indicator for polarization index	14	Unit symbols
15	The continuity buzzer is on	16	Compare feature pass
17	Analogue bar graph	18	Risk of electric shock
19	Compare feature fail	20	Indicator for power adaptor
21	Battery life indicator		

## V Key Functions

### ● ON/OFF

Turn on or off the Meter. Press and hold the button for 1 second to turn the Meter on. Press again to turn off the Meter. The Meter defaults at 500v

range and under continuous measurement of insulation resistance when turned on.

- **LIGHT**

Press to turn on/off the backlight.

- **CLEAR**

Press to clear the saved data.

- **SAVE**

Press to store the current measurement value. The Meter can save up to 18 sets. When the stored readings memory is full the Meter shows FULL and stop storing. Press and hold CLEAR to clear the stored value in order to store the next measurement value.

- **LOAD**

Press once to recall the first stored value.

Press again to exit Load feature.

load feature can only be used when there is no high voltage output.

- **▲**

When the insulation resistance measurement has no testing voltage output, press to select previous voltage range .

Under load mode press to recall the previous stored value.

- **▼**

When the insulation resistance measurement has no testing voltage output, press to select next voltage range.

Under load mode: press to recall the next stored value.

- ◀

When setting the timer for the measurement of insulation resistance or polarization index, press to decrement the time, The maximum length of time is 15 minutes and 30 seconds, the Meter will automatically carry out measurement.

When compare function is enabled for insulation resistance measurement press to decrement a resistance comparing value. After polarization index measurement press to display polarization index, TIME 2 and TIME 1 insulation resistance values in sequence.

- ▶

When setting the timer for the measurement of insulation resistance or polarization index, press to increment the time. The maximum length of time is 30 minutes and 30 seconds. The Meter will auto carry out measurement.

When compare function is enabled for insulation resistance measurement, press to increment a resistance comparing value.

After polarization index measurement, press to display polarization index, TIME 2 and TIME 1 insulation resistance values in sequence.

- COMP

Set a pass/fail limit for insulation tests, The default value is 10MΩ.

- TIME

Press to step through continuous, timed and polarization index measurements in sequence

- TEST

Press to stop or start an insulation resistance test.

- IR

Press to initiate insulation resistance measurement.

- DCV

Press to initiate Dc voltage measurement.

- ACV

Press to initiate AC voltage measurement.

## VI Measurement Operation

**This section explains how to make measurements.**

1. Press and hold ON/OFF to turn on the Meter, press again to turn off the Meter. The Meter defaults at 500V range and under continuous measurement of insulation resistance when turned on A Measuring Voltage.

2. Battery Saver(Sleep Mode)





The Meter enters the Sleep Mode and blanks the display after 15 minutes inactivity This is done to conserve battery power. The Meter comes out of Sleep Mode when ON/OFF button is pressed and hold for 1 second.

3. Battery Indication

There is a battery indicator shown on the upper left corner of the display. Please refer to Table 1 for detailed explanation.

Table 1. Battery Indication

Battery indicator	Battery Voltage
-------------------	-----------------

	10V or less. It means the battery is empty, don't use the Meter as it cannot guarantee accuracy.
	10V-10.5V It means the battery is almost empty replacing battery is necessary. Under this status, the Meter can still output 500V and 1000V to measure, the measured accuracy will not be affected.
	10.6~11.5V
	11.6V or more

When charging battery is applied, the charging battery work mode should be selected at the startup: Press and hold USB button prior to startup, then press down ON/OFF, LCD screen will display CHA or GEN, and select to display CHA by pressing the up/down key, after pressing USB key to confirm, the Meter successfully enters the charging battery work mode. GEN means the general alkaline battery work mode.

## VII Measurement

### 1. Voltage Measurement (connection diagram see Figure 4)

- 1) insert the red test line into the "V" input port. The green test line is inserted into the "COM" input port.
- 2) connect the red and green crocodile clip to the tested circuit. When measuring the DC voltage, if the red test line is negative voltage, then the "-" negative symbol is displayed on the LCD.

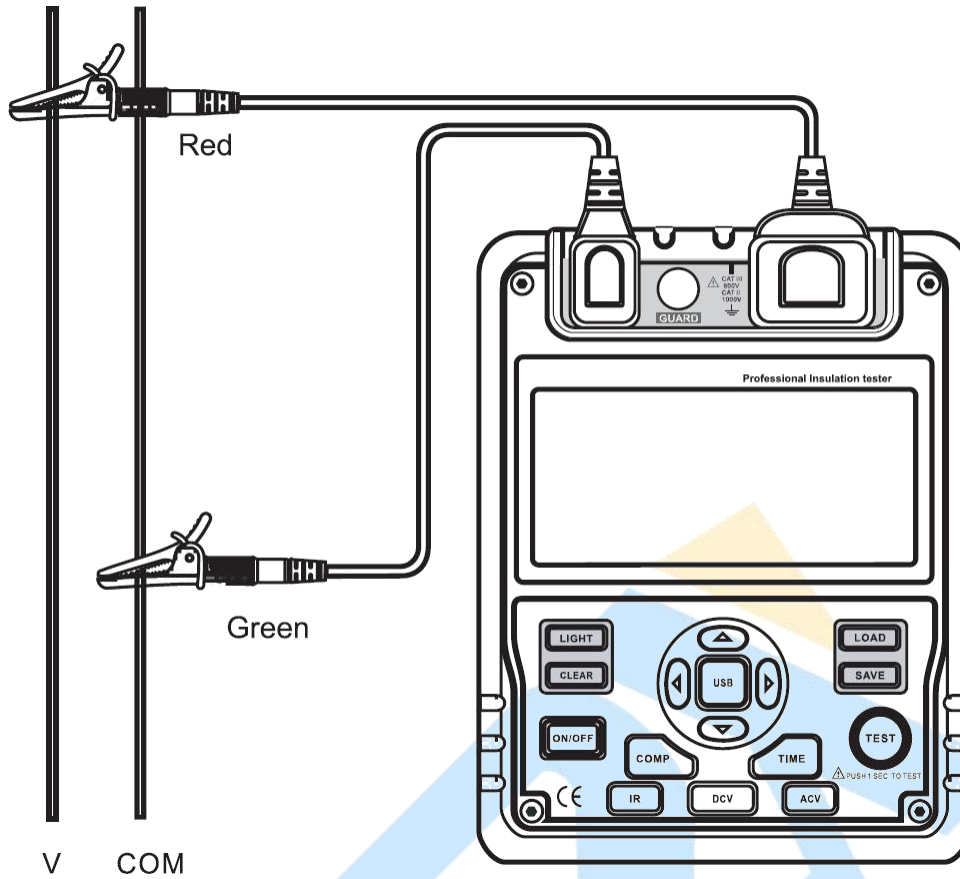

Figure 4

 **Caution**

Do not measure a voltage higher than 600V or 600Vrms. It is possible to display higher voltage, but it is dangerous and may cause damage to the instrument.

- \* when measuring high voltage, pay special attention to avoid electric shock.
- \* after completing all the measurement operations, we must disconnect the test line from the tested circuit and remove the test line from the input end of the instrument.

2. Insulation resistance measurement (connection diagram see Figure 5)

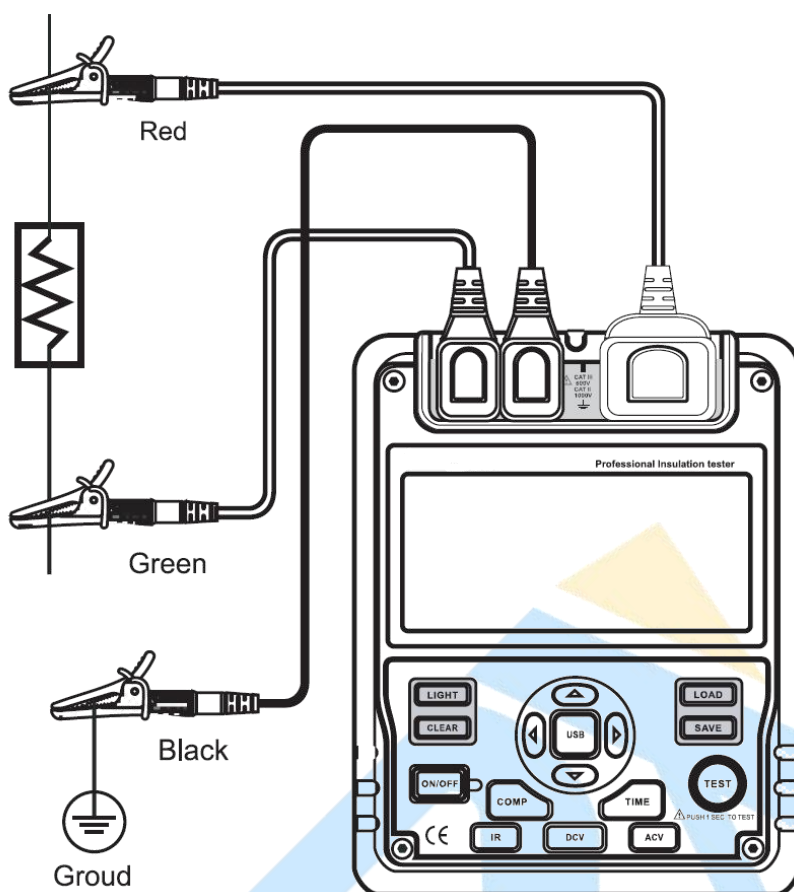

Figure 5

**⚠ Operating Caution**

- \* before testing, remove all power from the circuit to be measured or disconnect all the power. Do not measure the insulation in live line.
- \* Be careful that this instrument has dangerous voltage output, ensure that the test object is firmly clipped, hand away from the test clip, then press the TEST key to output high voltage.

**⚠ Special attention**

Do not short circuit two test leads during high voltage output or to measure insulation resistance after high voltage output. This improper operation is very easy to generate sparks and cause fire and damage the instrument itself.

**⚠ Operating Caution**



Don't measure over 10 seconds when



measurement resistance is lower than  $2M\Omega$  with use of 500V

measurement resistance is lower than  $5M\Omega$  with use of 1000V

measurement resistance is lower than  $10M\Omega$  with use of 2500V

measurement resistance is lower than  $20M\Omega$  with use of 5000V

When press IR to select insulation resistance measurement but no test voltage output, press arrow buttons to 500V/1000V/2500V/5000V voltage range.



- 1) When performing insulation resistance tester, remove all power from the circuit to be measured or disconnect all the power.
- 2) insert the red test line into the "LINE" input port, black test line to "GUARD", green to "EARTH"
- 3) Connect the red and black crocodile clip to the tested circuit, negative voltage outputs from LINE terminal.
- 4) select one of the following insulation resistance measurement mode:
  - Continuous measurement
- 1) Press TIME button to select continuous measurement mode, there is no timer icon on the LCD screen
- 2) Press left arrow button and hold right arrow TEST button for 1 second to carry out and output insulation resistance test voltage, the red Test button light up,  blinks on every 0.5 seconds.
- 3) Press TEST button turn off the voltage output after test, TEST button lights off,  disappears. The CLD shows the current insulation resistance test

value.

- Timed measurement

- 1) Press TIME button to select the mode, LCD displays "TIME1" and the timer symbol. Press arrow buttons to set the time ("00:10" and "15:00, within 1 minute, the time increment or decrement by every 5 seconds, afterward, the time increment or decrement by every 30 seconds), and then press down the TEST button for 2 seconds to carry out measurements. Time1 and  are displayed and blinked on the LCD on every 0.5s.
- 2) When set time is reached, the test voltage output will be turned off, and the measurement will be automatically stopped. The LCD displays the insulation resistance reading.

- Polarization index / PI measurement

Press TIME button to select the mode, LCD displays "TIME1" and timer symbols, press arrow buttons to set time ("00:10" and "15:00, within 1 minute, the time increment or decrement by every 5 seconds, afterward, the time increment or decrement by every 30 seconds). After sett TIME1, press TIME button, "TIME2", "PI" and timer symbols appears on the LCD. Press arrow buttons to set TIME2 (00:15 ~ 15:30, within 1 minute, the time increment or decrement by every 5 seconds, afterward, the time increment or decrement by every 30 seconds). Then press TEST button for 2 seconds, before TIME1 setting time is reached, TIME1 and  displayed and blinked on the screen on every 0.5 seconds. Before TIME2 set time is reached, TIME2 and  displayed and blinked on the screen on every 0.5 seconds. When two set

time are reached, the test voltage output will be turned off . The LCD displays the polarization index reading. Press arrow buttons to step through the PI, TIME1 and TIME2 insulation resistance readings.

- Calculation tips: polarization index =3 min ~ 10min resistance /30sec ~ 1min resistance
- absorption than =60sec value /15sec value

PI	4 or more	4~ 2	2.0~ 1.0	1.0 or less
Standard	The best	Good	Warning	bad

- Compare function
  - 1) Press COMP button to select compare feature. COMP symbol displays on the LCD
  - 2) Press arrow buttons to set the compare value
  - 3) You can choose compare from 10MΩ、20MΩ、30MΩ、40MΩ、50MΩ、60MΩ、70MΩ、80MΩ、90MΩ、100MΩ、200MΩ、300MΩ、400MΩ、500MΩ、600MΩ、700MΩ、800MΩ、900MΩ、1GΩ、2GΩ、3GΩ、4GΩ、5GΩ、6GΩ、7GΩ、8GΩ、9GΩ、10GΩ、20GΩ、30GΩ、40GΩ、50GΩ、60GΩ、70GΩ、80GΩ、90GΩ、100GΩ、200GΩ、300GΩ、400GΩ、500GΩ、600GΩ、700GΩ、800GΩ、900GΩ
  - 4) Press TEST button for 2 seconds, the NG symbol will display if the insulation resistance value is smaller than compare value. Otherwise GOOD symbol will be displayed

## VIII Replacing The Battery

## Warning

- \* Don't mix to use old and new batteries
- \* be careful the polarity is correct when installing batteries
- \* Do not use the meter if the battery indicator show a battery empty conditions
- \* Do not carry out measuring during the battery cover is open

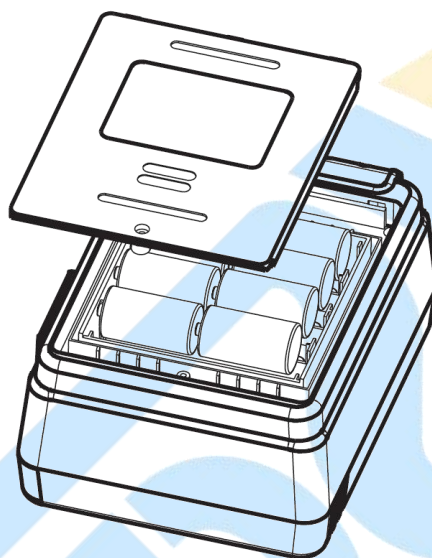

Figure 6

Follow figure 6 and proceed as follows:

- 1) Turn the meter to OFF and remove all connections from the terminals
- 2) Remove the screw from the battery cover, separate it from the case bottom, replace the batteries
- 3) Rejoin the case bottom and battery cover and reinstall the screw

## IX How to use power adaptor

Open the side safety shutter, then you will see there is a power adaptor input terminal, make sure the meter is power off and insert the power adaptor to the

input terminal,It is highly recommended to take out all the batteries when you are using the power adaptor

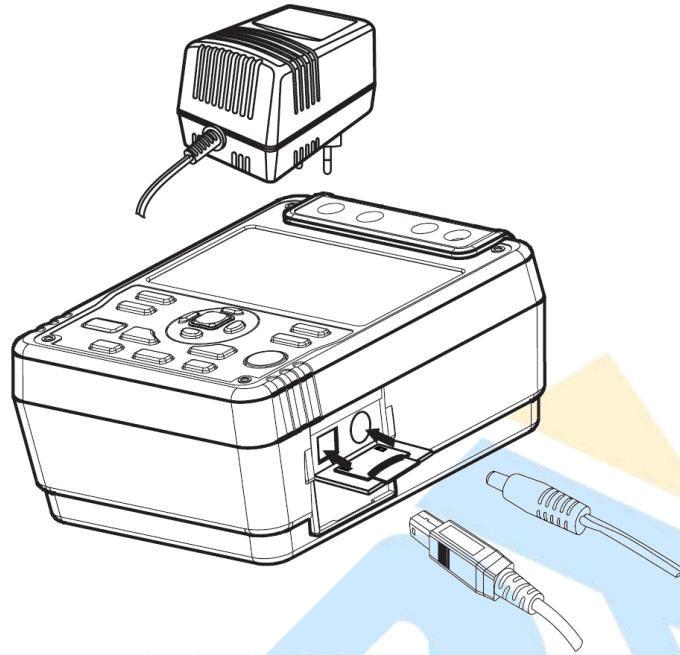

Figure 7