

ZXDN-3B Intelligent Energy Meter Calibrator



Warning

1. Do not clip the pulse line clip onto the voltage terminal of the energy meter; please do not insert the voltage terminal line into the current terminal;
2. Do not insert the current terminal into the voltage terminal;
3. Make a right choice of the work power supply (Note: the working voltage range of switching power supply is AC57.7 V ~ 440 V);
4. Choose the current range correctly, and the current range generally does not exceed 200% of the rating;
5. Each clamp meter has positive and negative ends: "+" end is the current input, and "-" end is the current output; please do not connect them reversely;
6. The clamp meter's color represents a different phase: yellow - A phase, green - B phase and red - C phase;
7. Do not mix different phases of clamp meter, or else it could affect the accuracy of measurement;
8. At the time of three-phase three-wire measurement, please do not connect B phase voltage line and current line to the instrument, lest affect the accuracy of measurement.
9. instrument has a built-in power supply, which can supply power from voltage terminal; please select the instrument's battery or external power supply.

Contents

I 、 Overview.....	- 4 -
II 、 Features.....	- 4 -
III、 Technical Indicators.....	- 6 -
IV、 Function Description.....	- 7 -
1. External Structure.....	- 7 -
2. Introduction to function keys.....	- 7 -
V 、 Function Description.....	- 10 -
1. Main interface introduction.....	- 10 -
2. Instrument charging.....	- 12 -
3. Brightness adjustment of LCD panel.....	- 12 -
4. User information.....	- 13 -
5. Character input and deletion.....	- 13 -
VI、 Wiring Method.....	- 14 -
1. Connection method for calibration of three-phase three-wire system energy meter.....	- 14 -
2. Connection method for calibration of three phase four wire system energy meter.....	- 14 -
3. Connection method for calibration of single-phase energy meter.....	- 15 -
4. Pulse input connection.....	- 16 -
VII、 Use introduction.....	- 17 -
1. Calibrate the energy meter's active and reactive errors at the same time.....	- 17 -

2. Comprehensive error measurement of energy meter.....	- 18 -
3. Ratio measurement.....	- 19 -
4. Analysis on line inspection.....	- 21 -
5. Harmonic analysis.....	- 23 -
6. Time Settings.....	- 25 -
7. Data Query.....	- 25 -
8. Communication.....	- 26 -
VIII、 Frequently Asked Questions.....	- 26 -
IX、 Packing List.....	- 28 -



I 、 Overview

ZXDN-3B Three-phase energy meter field calibrator is an advantageous product among electric energy metering series products of the company, and is integrated with energy meter calibrator and low voltage metering device, with energy meter error calibration, error wiring judgment, measurement of transformation ratio, meter reading, harmonic measurement and other functions.

II 、 Features

1. A high brightness, high definition and high resolution TFT color LCD screen shows clearly and beautifully, with large information content and rich content, and the screen shows all the parameters measured on the site.
2. Single and three phase voltage, current, power, phase, active and reactive power factor, frequency and other parameters can be in real time measured.
3. The energy meter and terminal errors can be calibrated, and single-phase and three-phase electronic induction active and reactive energy meters can be inspected.
4. The pulse input modes include manual input, photoelectric input and electric pulse input three ways.
5. 100A, 500A and 1000A clamp meters are optional, and the transformation ratio of low voltage current transformer is directly measured; it is easy to find the open circuit and poor contact in the CT secondary circuit, internal

turn-to-turn short circuit of CT and whether the transformation ratio on the CT nameplate is consistent with the actual transformation ratio of CT.

6. It can measure the content of the 2nd ~ 51st harmonics of single and three phase voltage and current.
7. The waveforms of A, B and C-phase voltage and current can be measured.
8. A wide range of working power supply is AC57 ~ 450V; the test line, adapter and battery power supply can be chosen respectively, and online charging is available.
9. With a large capacity memory card, it can store field calibration data of more than 10000 groups of energy meters, and U disk storage is supported; such data can be permanently saved upon non-human deletion
10. The ground software system can connect with the marketing system, with a friendly interface, easy operation, complete functions and easy to upgrade; the test data cannot be changed, and the software has the functions such as statistics, query, and printing; the test report format can be set according to the requirements of users.
11. Read the record data of multi-function electronic energy meter including the reading data, pressure loss records and clock.
12. The calibrator has the function of clamp transformer self-correction and NO need to return to factory for calibration after replacing the clamp meter.
13. Clock error calibration;
14. Broadcasting timing or command timing of the energy meter can be done (subject to the calibrator time);

15. The rate and time period of the energy meter, demand register and others, and demand value error can be read and set.
16. With the function of small current detection, it is convenient for initial installation and no-load line inspection.
17. Support for bar codes and 2D code scanning input, and an external barcode scanner (USB or wireless way) can read the meter asset number and seal number, etc., convenient for field entry;(optional)
18. With bluetooth, WIFI and GPS interface for options

III、 Technical Indicators

Voltage range	AC 40-440V	
Current range (double overload)	Terminal input	5A, 1A
	Clamp meter input	5A 20A 100A 500A 1000A 1500A
Grade	5A Terminal, 1A Terminal	0.05
	5A clamp (With the function of self-correction) , 20A clamp	0.2
	100A, 500A and 1000A	0.5
Power pulse constant	5A Terminal, 1A Terminal, 20A clamp, 5A clamp, 100A clamp, 500A clamp and 1000A clamp	FL=36000P/kWh FH=3.6×10 ⁸ P/kWh
Frequency	45-65Hz	
Phase measurement range	-180 -- +180 degrees	
Transformation ratio of Transformer	< ±0.5%	
Voltage influence	< ±0.01%	
Frequency influence	< ±0.01%(45-65Hz)	
Temperature influence	< ±5ppm/°C	
24h deviation	(0.1)< ±0.02% (0.05)< ±0.01%	
Basic errors	U.I Harmonic measurement	
Terminal input	Measuring range	2nd-51st harmonics

Active power	±0.1% ±0.05%	Accuracy of measurement	±0.01% (relative to 100% fundamental wave)
Reactive power	±0.1%	Other technical indicators	
Power	±0.1% ±0.05%	Switching power supply	AC57.7~440V (45~65Hz)
Voltage	±0.1% ±0.05%	Power consumption	About 6VA
Current	±0.1% ±0.05%	Environment temperature	-20`C--+40`C(Guaranteed accuracy)
Frequency	±0.05Hz	Relative humidity	40%-95% No condensation
Phase	±0.1 degree ±0.05% degree	Warm-up time	< 3min
Weight	1.8kg	Overall dimensions	(L)249*(W)154*(H)58mm

IV、Function Description

1. External Structure



2. Introduction to function keys



[F1] Clamp meter terminal or clamp meter input selection in the state of main screen. In the condition of harmonic analysis and waveform, view A phase harmonic or wave shape;

[F2] Automatically match the number of laps when checking errors in the state of main screen. In the condition of harmonic analysis and waveform, view B phase voltage harmonic or wave shape.

[F3] Commonly used constant choice in the state of main screen; in the condition of harmonic analysis and waveform, view C phase voltage and current harmonic, and wave shape.

[F4] The main screen calibration record delete key and power supply mode switch function key.

[F5] Suspend the interface jumping, and save when the main screen shows error checking.

[0] Automatic matching and testing of the energy meter's not constant.

[←↑→↓]: Up and down, left and right direction keys.

[Storage] Used to store the current calibration data

[Set] Used to set the field parameters.

[Query] Used to inquire the stored calibration data.

[Switch] Used to switch between input methods and between single meter and double meter.

[Exit] Cancel and exit.

[Enter] Confirm button

[1 transformation ratio] Number 1, and measurement of transformation ratio.

[2 line inspection] | Number 2, abc and wiring inspection error analysis.

[3 harmonics] Number 3, def and harmonic analysis.

[4] counter] Number 4, ghi and measuring meter counting, or electrical energy consumption

[5 | PT – CT] Number 5, jkl

[6] U disk] Number 6, mno and instrument stored data switched to U disk, read calibration plan in U disk, read user information in U disk, and upgrade the instrument through the U disk.

[7] timing] Number 7, pqrs, timing function

[8] waveform] Number 8, tuv, waveform analysis.

[9] Number 9, wxyz, communication function.

[Self-checking]] Clamp meter correction function.

[System] system management function key

[Meter reading] + / - and meter reading function key

[Switch]] Instrument power switch.

V、Function Description

1. Main interface introduction

Open the instrument power supply, and the screen shows the diagram below:

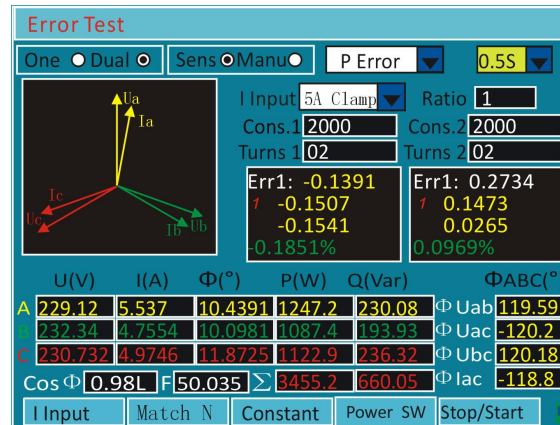

Press [$\leftarrow\rightarrow$] key to set single meter, double meter, photoelectric, manual, active and reactive power, level and other parameters.

Press [set] to set the constant and number of laps.

Press [F1] to input current, press [F2] and the instrument automatically matches the number of laps; press [F3] for recommended constant choice, and press [F4] to switch the power supply. Press [F5] to switch Suspend and Start measuring.

Field settings:

Constant: refers to the measured energy meter's constant. Press [Set] key to set parameters

Laps: refers to the error calculation by the instrument at a time after how many times pulse signals are received; specifically, as for a mechanical energy meter, it is the error calculation at a time after how many times black marks are received. (In the manual mode, press the manual switch after how many

times black marks are received)

Active (reactive): refers to the measured energy meter active or reactive. The default of double meter calibrator: meter 1 active, and meter 2 reactive.

Photoelectric (manual): pulse sampling method

Input: refers to the current sampling method

Ratio: the nominal value on the transformer nameplate (if it is a straight meter, the ratio is 1, and under other cases, it is input based on the on-site TA transformation ratio).

Vector graph: indicates the relationship between current and voltage vector at the time of measurement.

Electrical parameter area:

Shows all electrical parameters, including the following kinds:

$U_a, U_b, U_c, I_a, I_b, I_c, F$ (frequency), $P_a, P_b, P_c, Q_a, Q_b, Q_c, \Sigma P, \Sigma Q$

φ_A (angle of A phase voltage to current) φ_B (angle of B phase voltage to current)

φ_C (angle of C phase voltage to current) φ_{Uab} (angle of A phase voltage to B phase voltage)

φ_{Uac} (angle of A phase voltage and C phase voltage) φ_{Ucb} (angle of C phase voltage and B phase voltage)

φ_{Iac} (angle of A phase current to C phase current) $\cos\Phi$ (power factor)

F (frequency)

Power supply mode identification: the power supply modes include voltage terminal power supply, battery power supply and adapter power supply; the

priority from high to low is adapter power supply, voltage terminal power supply and battery power supply respectively.

In the main interface, press [F4] to switch power supply mode; the plug icon indicates an external power supply and the battery icon indicates the battery power supply.

Green means the present power supply mode. For instance: the present power supply mode is battery power supply and the battery icon is green.

Battery status identification: when the battery status identifier is green, the battery is electric; when it is red, the battery power is insufficient, and when it is white, the battery is fully recharged.

2. Instrument charging

The instrument's charging time is about 6-7 hours; the instrument is able to maintain about 5 to 6 hours of continuous work in full battery status.

Operating steps of charging:

- ① Connect the red end of 220V charging line to the instrument's A phase voltage terminal, and black line to the instrument's COM;
- ② Start the instrument.
- ③ The battery indicator light is green: the battery is fully charged, and red light: it is being charged.

3. Brightness adjustment of LCD panel

On the system function interface, press [F1] to enter into the screen brightness adjustment; press [←→] key to adjust the brightness and press

[enter] to store the current state of brightness. When using the battery power supply, reducing the display brightness will extend the battery life.

4. User information

User function is used to inquire the user information on the calibration data of the current main interface, including work order number, user number, user name, meter number, inspector and other data; the user information can be modified.

Operating steps:

① In the main interface, press [user] to view the user details about the calibration task, as shown below.

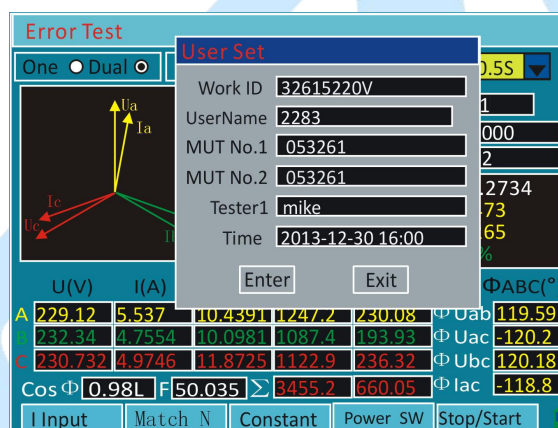

② Press [↓] and move the cursor, and input the information,

③ Press [Enter] key to save the user information; and return to the main screen.

5. Character input and deletion

Character deletion

Delete the entered characters, move the cursor to the characters needed to be deleted, and press F5 key to delete.

Press [F3] to delete all of the characters on the current line.

VI、Wiring Method

1. Connection method for calibration of three-phase three-wire system energy meter

When measuring a three-phase three-wire energy meter, connect U_a , U_c and U_b of the energy meter to be measured to the instrument's U_a , U_c and COM voltage ends respectively, connect the energy meter's I_a and I_c to the instrument's A, C phase current ends (do not plug a wire into the instrument's B phase voltage end and current end); connect the pulse input device to the energy meter's photoelectric socket.

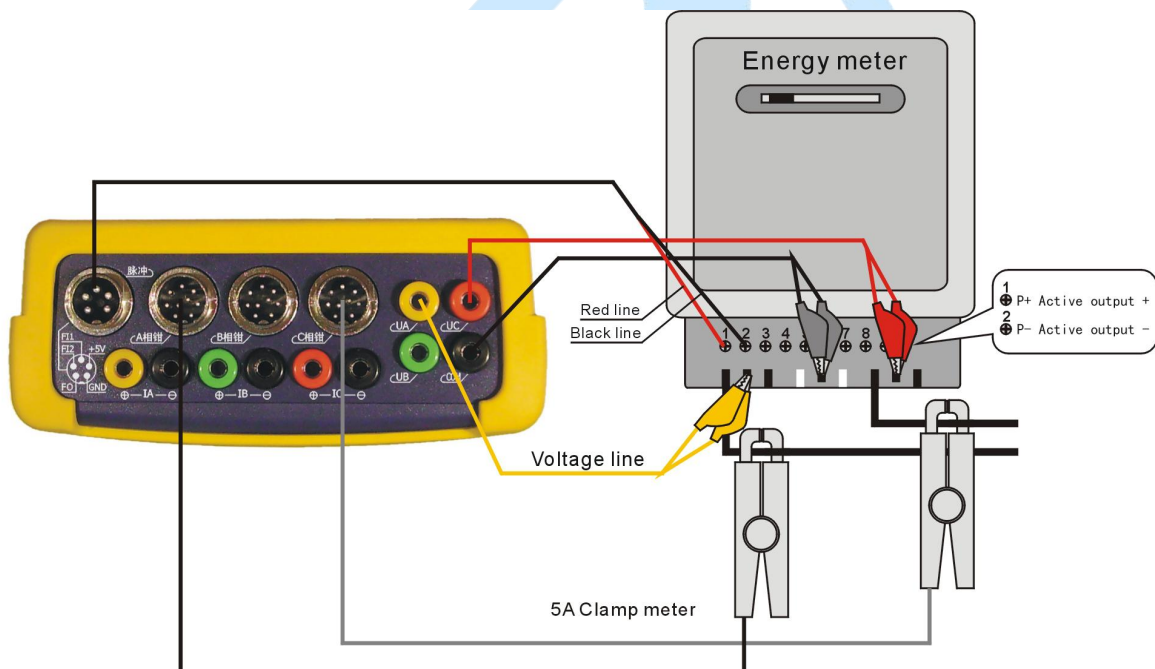

2. Connection method for calibration of three phase four wire system energy meter

When measuring the three phase four wire system, connect the U_a , U_b , U_c and COM of the energy meter to be measured to the instrument's U_a , U_b ,

Uc and COM voltage ends respectively; connect the energy meter's Ia, Ib and Ic to the instrument's A, B and C phase current end; connect the pulse input device to the energy meter's photoelectric socket.

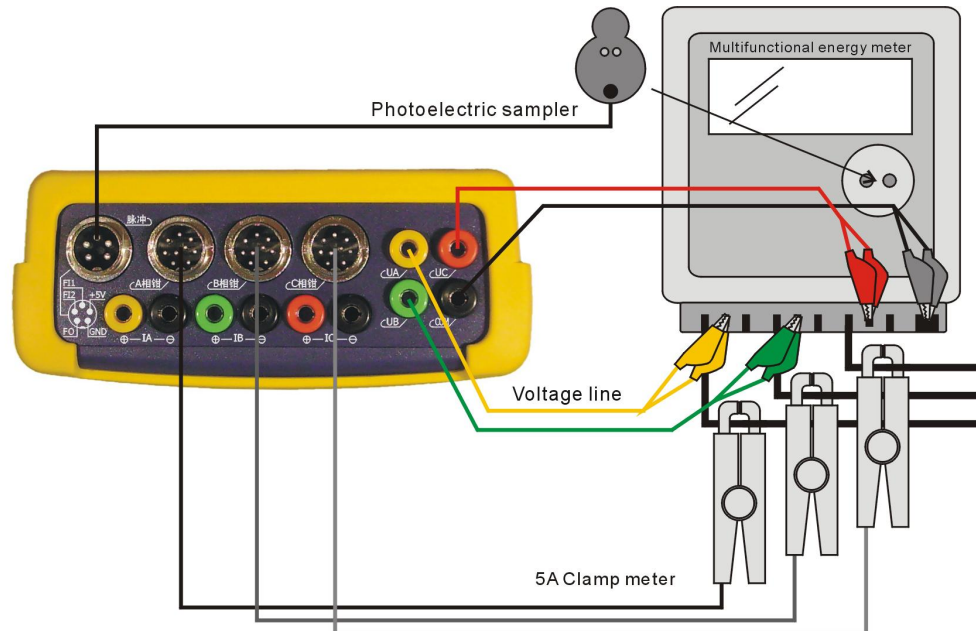

3. Connection method for calibration of single-phase energy meter

Connect the "live" wire and U0 of the energy meter to be measured to the "zero" line and connect to any phase of the instrument's A, B and C phase voltage terminals; if the voltage is connected to A phase, connect the current line of A-phase clamp energy meter; connect the pulse input device into the energy meter's photoelectric socket.

Note:

- ① when the instrument is supplied with voltage from the live wire inlet, the clamp meter should be connected to the live wire outlet; otherwise it will affect the calibration of accuracy error;
- ② when the instrument is supplied with voltage from the live wire outlet, the clamp meter should be connected to the live wire inlet;

otherwise it will affect the accuracy of calibration error. As shown below (voltage from the live wire inlet):

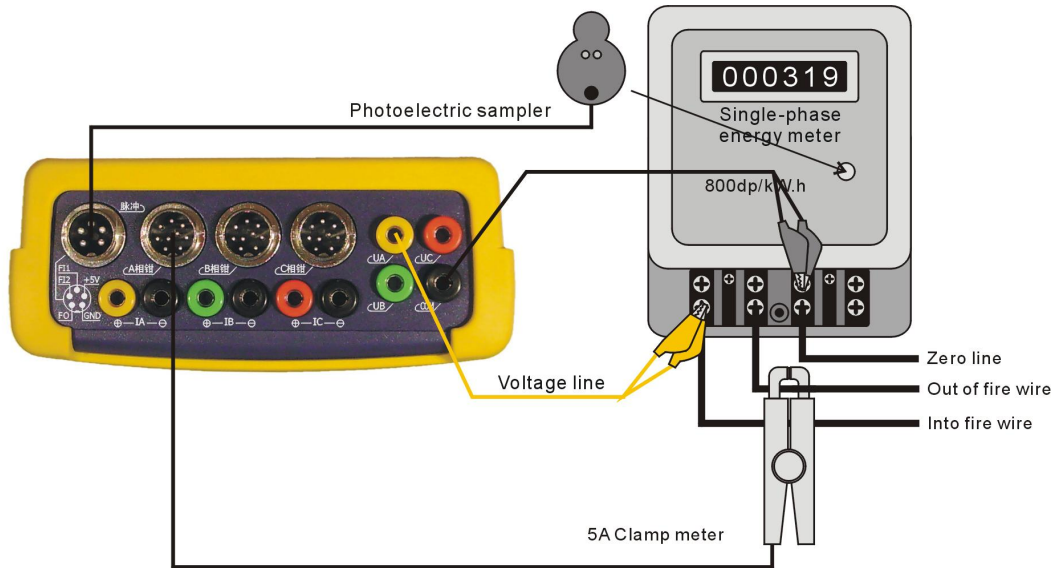

As shown below (voltage from the live wire outlet)

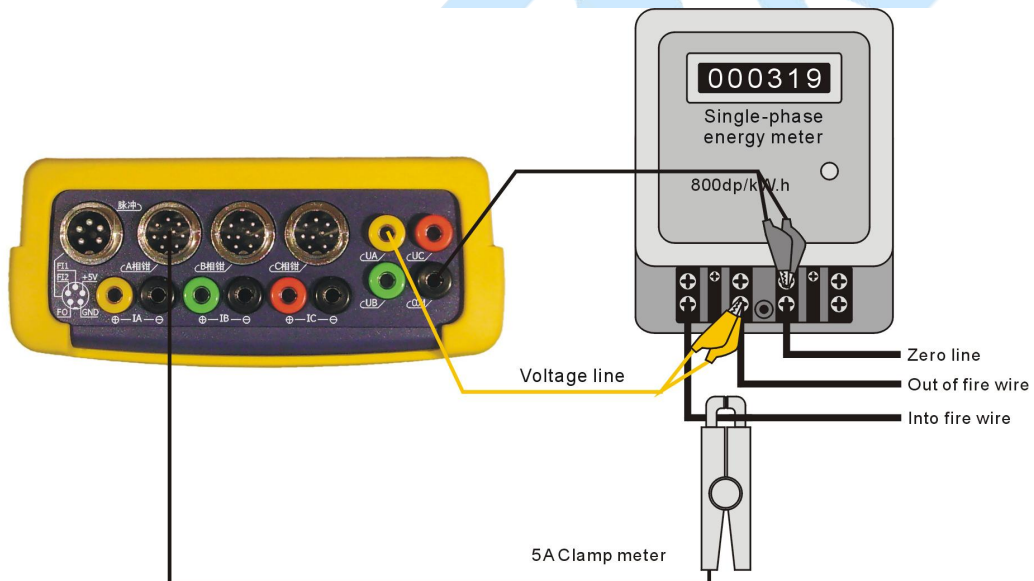

4. Pulse input connection

According to the calibration mode adopted, connect the corresponding pulse input device (photoelectric sampler or electronic energy meter pulse line) to the photoelectric head socket.

Calibrate the primary and secondary meters at the same time

Take a three phase four wire meter as an example

When calibrating the primary and secondary meters at the same time, the connection of other three phase four wire lines besides pulse connection is the same (please see the connection method of three phase four wire) pulse wiring method: connect the pulse acquisition line 1 to the primary meter, and connect the pulse acquisition line 2 to the secondary meter)

VII、 Use introduction

1. Calibrate the energy meter's active and reactive errors at the same time

The calibrator can measure the energy meter's active and reactive errors at the same time.

For example: the checked three-phase three-wire electronic energy meter 3 x 100V, 5A clamp meter input, energy meter active constant: 8000 r/kW. h and energy meter reactive constant 8000 r/kvar. h. Photoelectric calibration, number of active laps: 3 laps and number of reactive laps: 2 laps. The interface displays as below:



The operating steps are as follows:

- ① Open the instrument, and connect the lines;

- ② Press [←→] key to choose: "double meter" Press [Enter] to take effect;

Note: choose the double meter, and the instrument will automatically act to check active and reactive power error by default.

- ③ Press [←→] to choose: "photoelectric" Press [Enter] to take effect;

- ④ Press set key, constant 1 input "08000"; number of laps 1 input: 02;

- ⑤ Constant 08000; number of laps 2: 02

- ⑥ Press [F1], and choose "5A clamp meter" as input option.

⑦ Shortcut: [F1] current input, [F2] matching laps, [F3] recommended constant option, [F4] power supply switching, and [F5] suspend/start.

⑧ After error measuring is stable, press [Storage] to input the user information.

- ⑨ Press [Enter] to store the calibration data.

Note: 1. 5A clamp meter, 1A clamp meter with the function of automatic shift, such as field current: 0.5A, measured by 5A clamp meter, input: 5A clamp, and the instrument automatically switches to 1 A clamp. 2. 5A terminal and 1A terminal with the function of automatic shift.

2. Comprehensive error measurement of energy meter

For example: the rated current of a low-voltage three-phase four-wire transmission line is 500A, and its metering device consists of 500/5 TA, 3 x 220V/5A active energy meter with meter constant of 600 r/kW.h; the comprehensive error of entire metering device now needs to be measured.

Operation method:

- ① Open the instrument, take 500A clamp meter as input current, and clip

the clamp meter onto TA primary current line (pay attention to current direction);

- ② Press [set] to set the meter parameters, constant: 600, number of laps: 2 laps, input: 500A clamp meter, and ratio 100;
- ③ Choose active and photoelectric calibration mode;
- ④ The settings are as follows:

Parameters Setting			
Cx1	600	N1:	2
Cx2	600	N2:	2
I (in)	5AClamp	Multi	1
Ratio	5/5	M1Grade	1
Count	One	M2Grade	2
Pluse	Sens	Way	P Error
Output Cx	3600		

- ⑤ After settings, press [Enter] to begin with comprehensive error measurement.
- ⑥ After error measuring is stable, press [Storage] to input the user information.
- ⑦ Press [Enter] to store the calibration data.

3. Ratio measurement

Operating method:

- ① connect 500A clamp meter to the instrument's A-phase clamp meter interface, and clip the primary side of A-phase TA;
- ② connect 5A clamp meter to the instrument's C-phase clamp meter interface, and clip the secondary side of TA (Pay attention to the direction of current) ;

③ Press [1|transformation ratio] key to enter CT measurement of transformation ratio interface, press [F2] to select the primary clamp meter: 500A, and press [F3] to select the secondary clamp meter: 5A; as shown below:

CT Ratio Measure	
Primary CT <input type="text" value="500A"/>	Secondary CT <input type="text" value="5A"/>
Please insert primary CT to phase A of the device, and insert secondary CT to phase C of the device.	
Primary I <input type="text" value="503.60"/>	Ratio <input type="text" value="100.20"/>
Secondary I <input type="text" value="5.026"/>	Phase Differ <input type="text" value="0.065"/>
Keyboard prompt: Press <F2> to select primary CT Press <F3> to select secondary CT Press <Enter> to start measure ratio, Press <Exit> to exit.	
Measure Stop.	

④ After setting, press [Enter] to start the numerical measurement of transformation ratio. Press [Exit] key to exit and return to the main interface.

In order to measure other phase, the large and small clamp meters are respectively clipped onto the TA current line of the phase to be measured and the current input line of the energy meter, to measure the phase transformation ratio.

Result analysis: in case of the phase angle $> 5^\circ$ but $< 10^\circ$, the secondary load of TA could be heavy, including poor terminal contact.

In case of the phase angle $> 10^\circ$ but $< 90^\circ$, the secondary circuit or transformer may fail.

In case of the phase angle close to 180° , a clamp meter could be in the opposite direction.

Note:

- the measurement of transformation ratio is only limited to low-voltage system; remember that it cannot be used directly to measure the TA transformation ratio of high voltage system;
- In order to ensure the accuracy of measurement, it should be ensured that the jaw is clean.

4. Analysis on line inspection

Under the condition of different power factors, the error results identified by the instrument are different, but the result is only for each type of power factor.

Press [2 line inspection] key to enter the line inspection function interface

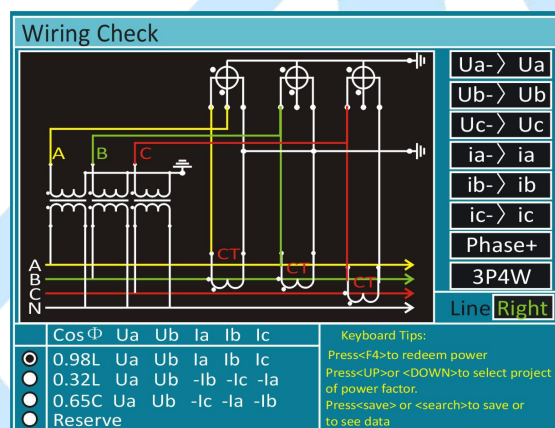

Press [$\uparrow\downarrow$] to choose power factor.

Press [Storage] to store the current line inspection results. Press [Query] to inquire the stored line inspection records.

Under the condition of different power factors, the error results identified by the instrument are different, so users must choose the power factor according to the load nature of the line that belongs to the calibrated meter.

Notes:

- Incorrect connection identification is the intelligent identification of the instrument's three-phase three-wire and three-phase four-wire line, to determine whether there is a wrong connection. The instrument can identify 48 kinds of common wrong wiring three-phase three-wire and 96 kinds of common wrong three-phase four-wire wiring.
- Only when the line inspection results are $U_a U_b I_a I_b U_c I_c$ or $U_a U_b I_a U_c I_c$, and the power factor is correct, the wiring is correct.
- When the wrong wiring is identified, the power factor can't be on the basis of $\cos\phi$ shown on the instrument itself. Because the field wiring is wrong, what reflected by $\cos\phi$ is not the real load power factor.
- When checking the line, if the asymmetric angle of current phase angle is too big, no error may be checked out. Especially with a low load, it is common.
- In practical application, $\cos\phi$ is generally perceptual, and the capacitive probability is very low. If compatibility is suspected, the reactive capacity compensation can be cancelled, and it should turn into sensibility at this time.
- After the connection error is found out, check whether the wiring of the instrument and meter end is correct, and then confirm whether the power factor is correctly chosen; after all is confirmed, change the meter connection according to the connection method found out, and check the line and the results should be correct.

Premise for correct line inspection:

Three phase three wire	Three phase four wire
Three-phase circuit symmetric	Three-phase circuit symmetric
Voltage and current wiring not wrong to each other	Voltage and current wiring not wrong to each other
Voltage and current circuit with no short circuit, open circuit	Voltage and current circuit with no short circuit, open circuit
Each secondary line voltage basically has the equal value	Each secondary line voltage basically has the equal value
With no current coil of B phase current access to the energy meter	Three phase current circuit has no resultant vector access

5. Harmonic analysis

1) Function description

Perform the 2nd ~ 51st harmonic analysis on the measured signal, and test the total harmonic distortion rate, the content of odd and even and each harmonic.

Press "3 harmonic" key, and the interface displays as follows:

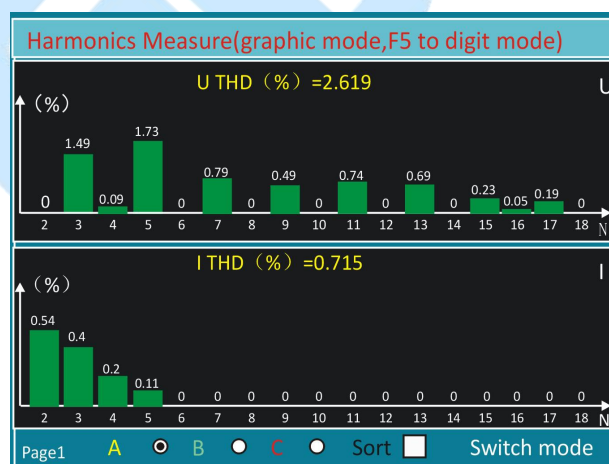

Press [←→] key to turn pages. Press [F4] to sort.

Press [F1] key to measure A phase voltage and current harmonics.

Press [F2] key to measure B phase voltage and current harmonics.

Press [F3] key to measure C phase voltage and current harmonics.

Press [F5] to switch to digital mode.

The instrument can measure 2nd ~ 52nd harmonics, show harmonic spectrums and give out the percentage content of each harmonic.

2) Explanation to name

The content of nth harmonic voltage is expressed as HRU_n .

Total harmonic distortion of voltage harmonic (THD_u) and total harmonic distortion of current harmonic (THD_i) are defined as, respectively

$$THD_u = (U_H / U_1) \times 100\% \quad THD_i = (I_n / I_1) \times 100\%$$

Harmonic order - refers to the multiples of fundamental wave frequency, relative to fundamental wave. If the frequency of mains supply is 50Hz, the 2nd harmonic is 100Hz AC component, the 3rd harmonic is 150Hz AC component and so on.

3) Harmonic influence

Harmonic pollution to power grid is becoming more and more serious, so the harm caused by harmonics can not be ignored, mainly reflected in:

- ① Greatly increasing the chance of resonance in power grid, thus causing the risk of accidents arisen from very high overcurrent or overvoltage;
- ② Increasing additional loss, and reducing the efficiency of power generation, transmission and power equipment and the equipment utilization;
- ③ Increasing the losses to electrical equipment (rotary motors, capacitors, transformers, etc.), accelerating the insulation aging, and thus shortening the service life;
- ④ Leading to the metering and measuring instruments (such as: energy

meter) not to give correct instructions or measurement;

⑤ Interfering with the communication system, lowering down the quality of signal transmission, disturbing the normal transmission signal, and even damaging the communications equipment.

6. Time Settings

1. Press [7] to enter into the time settings interface;

1) 2. Input time, and press [Enter] and the settings take effect.

7. Data Query

Query means to inquire the calibration records, line inspection results, and fundamental frequency error data stored in the instrument.

Operating steps:

Press [Query] to enter into the calibration data query interface as below:

Store the data by date, and the meter calibration data within the same date are stored in a folder named for the date.

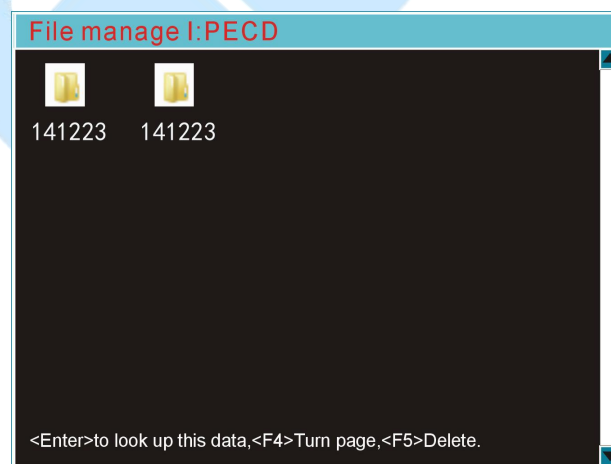

Press [Enter] key to view the calibration record on the date.

Press [Enter] to view the data details.

Note: if the calibration task you want to find can't be found on the

current interface, search by turning pages through [← →] key.

Press [F5] to delete the data of the current date.

8. Communication

1) Serial communication

Operating steps:

- ① Connect the computer to the instrument communication line.
- ② Start the instrument, and press [system] - [communication management] - [1] to enter the serial communication interface;
- ③ Open the background management software, choose [three-phase energy meter calibrator] - > [above 6.0 version (containing 6.0)] - > [read the calibration data].

VIII、 Frequently Asked Questions

1. Question: press down the power on/off key, but the instrument has not been open, why?

Answer: if the voltage terminal has no voltage input or no power adapter is used, the battery may be out of electricity. In case that the terminal voltage has input voltage (57.7V – 380V), the instrument may be fail if it cannot be switched on/off

2. Question: the instrument is suddenly abnormal at work, but the keys operation is also invalid, why?

Answer: there may be large interference, leading to the chip stopping; the power supply can be shut off to restart, and in general, this problem can be

solved;

3. Question: when the calibration error found is very large, if it is a relatively stable value, why?

Answer: (1) first of all, check whether the settings are correct, because it is often easy to mistake in the following

- a) The present current is greater than 1A, and it is set to 1A current shift;
 - b) When the input is greater than 100A, the set ratio is not correct;
 - c) The meter constant setting is abnormal;
 - d) Active and reactive power settings are incorrect;
 - e) Manual and photoelectric settings are not correct;
- (2) Check whether the clamp meter is in the reverse direction.

4. At the time of field testing, the error fluctuation is very big, how to do?

Answer: there may be several reasons below:

- 1) In the case of direct sunlight, it is the best to use an object to cover the photoelectric sampler to prevent hard light interfering with the photoelectric sampler
- 2) The load fluctuation is too large, and the energy meter and instrument have different reaction speed to increase the number of laps;
- 3) Harmonic motion is very large, and under the unstable case, a common energy meter can only be used for harmonic measurement, which may lead to big error and instability.

5. At the time of spot measurement, there is no current display

Answer: check whether the clamp meter or terminal connected with the instrument is the same as the current input option of the instrument.

6. At the time for measurement of comprehensive error, the error is big

Answer: there may be several reasons in the following:

1) The field load is instable;

2) The numerical value of TA transformation ratio is input by mistake;

3) The field harmonic interference is too large.

7. When the instrument is measured on the calibration console, the error is not stable

Answer: the calibration console's voltage may be used to supply the instrument, and the solution is to press F4 to select battery or adapter power supply.

IX、 Packing List

NO.	Name	Qty
1	Meter	1
2	Current clamp(5A)	3
3	Voltage test line	1
4	Alligator clip (5mm)	10
5	Pulse line	1
6	RS232	1

7	Charging Cable	1
8	Photoelectric head	1
9	PC software	1
10	manual	1
11	Test Report	1
12	Certificate/Warranty Card	1

