

ZXFZ-H Generator
Rotor Impedance Tester



Contents

I 、 Product Description.....	- 2 -
II 、 Features.....	- 2 -
III、 Technical Index.....	- 3 -
1. Environmental Conditions.....	- 3 -
2. Performance Indicators.....	- 4 -
3. Insulating Strength.....	- 4 -
IV、 Panel Description.....	- 5 -
V 、 Operating Instructions.....	- 6 -
1. Method of Keyboard Use.....	- 6 -
2. Introduction to the Main Interface.....	- 6 -
3. Introduction to Automatic Tests.....	- 7 -
4. Manual test.....	- 11 -
5. Data Browse Operation.....	- 14 -
6. System Setup Description.....	- 14 -
VI、 Wiring Diagram.....	- 15 -
VII、 Precautions for Use.....	- 16 -
VIII、 Common Trouble Shooting.....	- 16 -
IX、 Packing List.....	- 17 -

I 、 Product Description

The instrument adopts the state-of-the-art high speed microprocessor technology with more powerful functions, preferable performances and more convenient use. The Tester has a series of characteristics such as high reliability, easy operation, high test precision, being compact and lightweight and etc., and currently is in the domestic leading level.

II 、 Features

1. The Product can provide full automatic acquisition, measurement, display, storage and printing of all the measurement parameters and impedance characteristic curves (including voltage, current, impedance, power, frequency, equipment number, time, etc.)
2. The Product is characterized by ultra-wide measuring range, which can fully automatically or manually measure AC impedance and their characteristic curves of all the generator rotors.
3. The Product has built-in storage with super-large capacity, which can store the test data and upload the data to PC through the standard industrial communication interface (RS232). The downloading of data, automatic generation and compiling of typical test reports can be achieved using the software attached with the Product which was developed by our Company, so as to facilitate technical management and archiving.
4. The Product has perfect over-voltage and over-current protection functions,

in which the over-current and over-voltage protection thresholds can be automatically adjusted in accordance with the settings of the test parameters. Due to these characteristics, the device is simple and can ensure the safety of the equipment under test.

5. The Product can also be used for no-load and short circuit tests of single phase transformers as well as the volt-ampere characteristic tests of voltage (current) transformers and arc suppression coils.
6. The Product has a large screen graphic LCD with a full Chinese menu interface and cursor instructions, which is simple and convenient. The test data and curves can be displayed in real time and the curvilinear coordinates can be automatically scaled for a clearer map reading.
7. The Product is equipped with a miniprinter, which can print the AC impedance test reports and AC impedance characteristic curves in real time.

III、 Technical Index

1. Environmental Conditions
 - 1) Temperature: $-5^{\circ}\text{C}\sim 40^{\circ}\text{C}$
 - 2) Relative Humidity: $<95\%$ (25°C)
 - 3) Altitude: $<2500\text{m}$
 - 4) External Disturbance: No extra strong vibration or extra strong electromagnetic field
 - 5) Power Supply: $180\text{VAC}\sim 270\text{VAC}$, $45\text{Hz}\sim 65\text{Hz}$

2. Performance Indicators

- | | | |
|--------------------------|------------|------------|
| 1) AC Impedance: 0-1Ω | 0.2%FS±2d | |
| 1-6000Ω | 0.2% | |
| 2) AC Voltage: 0-50V | 0.2%FS±2d | |
| 50-600V | 0.2% | |
| 3) AC Current: 0-10A | 0.2% FS±2d | |
| 10A-120A | 0.2% | |
| 4) Active Power : 0—1kW | 0.1>CosΦ>0 | 1% FS±2d |
| | CosΦ>0.1 | 0.5% FS±2d |
| 1kW—72KW | 0.1>CosΦ>0 | 1% FS±2d |
| | CosΦ>0.1 | 0.5% FS±2d |
| 5) Frequency: 40-75HZ | 0.2% | |
| 6) Volume: 415×225×200mm | | |
| 7) Weight: 5kg | | |

3. Insulating Strength

- 1) The insulation resistances of voltage and current of the input terminal to shell should be equal to or greater than 100MΩ.
- 2) The withstand power frequency between the working power supply input terminal and the shell is 2KV (effective value) . The experiment lasts 1 minute.

IV、 Panel Description

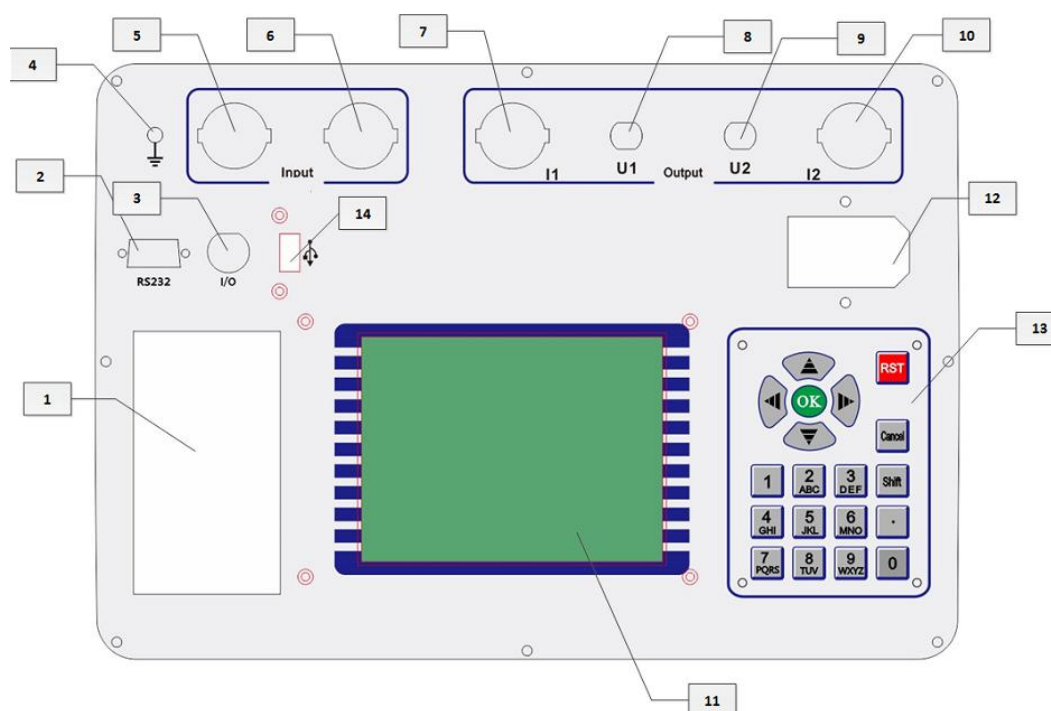

Fig 1 Panel view

1. Panel-type miniprinter;

2. Communication port;

3. Safety earthing terminal;

4. Ground terminal

5/6. Test the input terminal of test loop and connect the voltage regulator to output terminal. This tester adopts the dedicated high current quick coupling which should be slightly rotated when being connected and removed;

8/9. Test the loop voltage measurement terminal, within the measuring range from 0 to 600V;

7/10. Test loop current measurement terminal, within the measuring range from 0 to 120A. This tester adopts the dedicated high current quick coupling which is extremely convenient to use and should be slightly rotated when

being connected and removed;

11.Large screen LCD;

12.Working power switch of the instrument (220V);

13.Working power switch of the instrument;

14.Numeric keyboard, fairly convenient for input.

V、 Operating Instructions

1. Method of Keyboard Use

Press the “OK” key to select the current input; press “Cancel” to delete the just misinput; press “↑”, “↓”, “←” and “→” to move the cursor conveniently. The “Switch” key is an alternate key. The data keys of 0~9 are arranged in lower part of the keypad,for convenient input of data.

2. Introduction to the Main Interface

The main interface is shown in Figure 2 and consists of 4 modules.

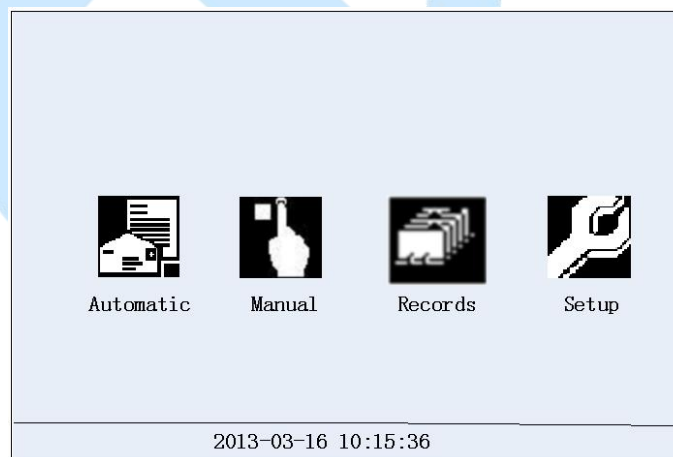

Figure 2 Boot Interface of the Tester

- 1) Automatic: Automatic AC impedance tests can be conducted according to the preset setting in the test item.
- 2) Manual: Manual AC impedance tests can be conducted in the test item.

- 3) Records: The data can be browsed and deleted.
- 4) Setup: The current system time and test parameters can be set.

3. Introduction to Automatic Tests

1) The working power of the instrument is switched on and the power switch is turned on. After the instrument is reset, the system will enter the interface as shown in Figure 1. Then you can press the “↑” and “↓” keys to select “Automatic” and press “OK” to enter the “Automatic Test Parameter Setup” interface as shown in Figure 3. The wiring diagram of the test is displayed on the right of the interface.

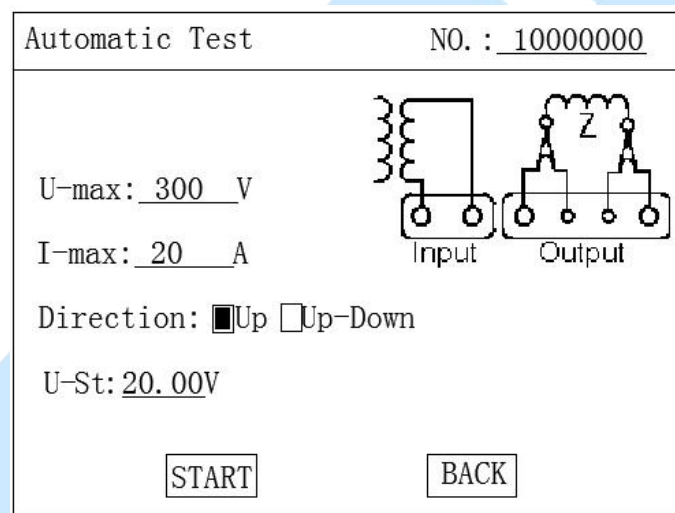

Figure 3 Automatic Test Parameter Setup Interface

Including:

① No. : which is used to differentiate different devices, different test properties and times so as to facilitate the search of historic data and technical management.

② Voltage step : which is defined as the voltage reference for each parameter data acquisition, the interval between the data acquisition data

voltage of the size of the number, range (5 - 50V).

③ U-max: which is referred to as the maximum voltage value to be tested in the tests. A voltage value of 1.1 times of the setting value is the default over-voltage protection operating value of the instrument. During the increasing voltage process, when the voltage or current exceeds the 1.1 times of the set value, the output is disconnected. The protection times can be changed in the setting of system.

④ I-max: which is referred to as to the maximum current value to be tested in the test. As similar to the set value of the maximum voltage, a current value of 1.1 times of the setting is the default over-current protection operating value of the instrument.

2) The voltage regulator, instrument and rotor winding under test are connected according to the wiring diagram as shown in the interface. More detailed wiring diagrams are available below.

Note: Be sure that the wires are connected according to the diagram on the instrument, otherwise, the instrument or other equipment may be burnt out!

3) The above parameters are set according to the test requirements and the cursor is moved to select “Start Test”. Then you can enter the “Automatic Test” interface as shown in Figure 4.

Automatic Test		f(Hz):50.00Hz		
	U(V)	I(A)	Z(Ω)	P(W)
1	20.1	0.3	67.0	4.52

21.02V 0.301A STOP

Figure 4 Automatic Test Interface

The current voltage frequency is displayed on the top of the interface; the main display area is in the middle part and shows the data captured; the real-time values of the current voltage, current and rotating speed are displayed on the bottom of the interface.

The acquisition according to the voltage step size: the voltage regulator in the interface can be adjusted so as to increase the voltage, and the instrument will automatically acquire the values according to the automatically-set voltage step size and display the measurement values of all parameters at various test points. Until the maximum set voltage value is reached, the buzzer of the instrument emits a beep which prompts you that the data measurement is finished. At this moment, if the test direction is unidirectional, the voltage regulator should be set as zero rapidly; else, if the test direction is bidirectional, the voltage is slowly reduced to zero.

Note: In case of misoperation which makes the output voltage or current exceed 1.1 times of the maximum set, the instrument will send the

prompt message of over-voltage. Here, you should immediately reduce the voltage and pay attention to whether the current voltage value is within the limits of the test object.

4) When the test is finished, the instrument will switch to the “Automatic Test Result” interface as shown in Figure 5.

Result				
	U(V)	I(A)	Z(Ω)	P(W)
1	20.10	0.30	67.0	4.520
2	40.10	0.60	67.0	16.92
3	60.09	0.89	67.2	37.42
4	80.10	1.23	67.2	67.40
5	100.1	1.52	67.6	125.3
6	121.1	1.84	66.8	162.3
7	140.0	2.10	66.8	189.6
8	160.2	2.39	67.0	225.1

Figure 5 Automatic Test Result Interface

In the current interface, you can press the key of “RETEST” to restart the measurements according the current settings; press the “SAVE” key to save the current test results in the storage of the instrument for future reference; and press the “PRINT” key to print the current test result through the printer on the panel. If you press the “CURVE” key, and the instrument will draw the “U-I” curve as shown in Figure 6 based on the measured data.

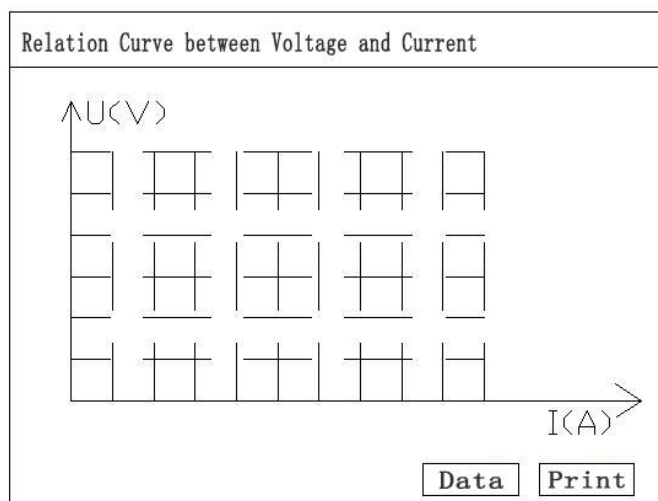

Figure 6 Relation Curve between Voltage and Current

Note: The instrument can display 50 sets of test results. If it exceeds, the instrument only records the first 50 sets of data.

4. Manual test

- 1) The working power of the instrument is switched on and the power switch is turned on. After the instrument is reset, the system will enter the interface as shown in Figure 1. You can press the “↑” and “↓” keys to select “Manual Test” and press “OK” to enter the “Manual Test Parameter Setup” interface as shown in Figure 7.。

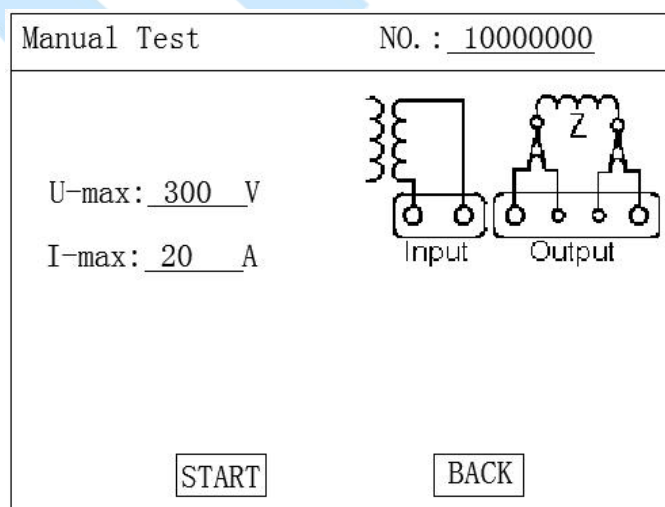

Figure 7 Manual Test Parameter Setup Interface

Including:

① Equipment number: is used to distinguish between different equipment, different test properties, frequency. In order to facilitate the search and technology management in historical data.

② U-max: which is referred to as the maximum voltage value to be tested in the test. A voltage value of 1.1 times of the setting value is the default over-voltage protection operating value of the instrument. During the increasing voltage process, when the voltage or current exceeds the 1.1 times of the set value, the output is disconnected. The protection times can be changed in the setting of system.

③ I-max: which is referred to as the maximum current value to be tested in the test. As similar to the set of maximum voltage, a current value of 1.1 times of the setting value is the default over-current protection operating value of the instrument.

2) The voltage regulator, instrument and rotor winding under test are connected according to the wiring diagram in the interface.

Note: Be sure that the wires are connected according to the diagram on the instrument, otherwise the instrument or other equipment may be burnt out!

3) The above parameters are set according to the test requirements and the cursor is moved to select “Start Test”. Then you will enter the “Manual Test” interface as shown in Figure 8.

Manual Test		f(Hz):50.00Hz		
	U(V)	I(A)	Z(Ω)	P(W)
1	20.1	0.3	67.0	4.52

21.02V 0.301A

Figure 8 Manual Test Interface

The voltage regulator in the interface can be adjusted to increase the voltage. When the real-time value is the desired voltage (or current) test point, you can press the “SAVE” key, and the instrument will automatically record the current data; and then the data display region on the interface displays a set of measured values of various parameters at this measured point and so on. Until all the desired test points are tested, the voltage regulator will be set as zero and the generator stops to rotate.

Note: In case of misoperation which makes the output voltage or current exceed 1.1 times of the maximum set, the instrument will send the prompt message of over-voltage. Here, you should immediately reduce the voltage and pay attention to whether the current voltage value is within the limits of the test object.

4) When the test is finished, the instrument will switch to the “Manual Test Result” interface as shown in Figure 9.

Result				
	U(V)	I(A)	Z(Ω)	P(W)
1	20.10	0.30	67.0	4.520
2	40.10	0.60	67.0	16.92
3	60.09	0.89	67.2	37.42
4	80.10	1.23	67.2	67.40
5	100.1	1.52	67.6	125.3
6	121.1	1.84	66.8	162.3
7	140.0	2.10	66.8	189.6
8	160.2	2.39	67.0	225.1

Figure 9 Manual Test Result Interface

In the current interface, you can press the “SAVE” key to save the current test result in the storage of the instrument for future reference; and press “PRINT” key to print the current test result through the printer on the panel. If you press “CURVE”, the instrument will draw the “Voltage/Current Relation” curve as shown in Figure 6 based on the measured data.

5. Data Browse Operation

In the main menu, you can move the cursor to select “Records” and press the “OK” key, and then the instrument will display all the saved historic data (in chronological order). According to the serial numbers of test time and equipment, you can move the cursor to select the key of “<-” or “->” or press the up and down arrow keys to search the required historical data, and press the key of “CURVE” to display the curves corresponding to the current data.

6. System Setup Description

In the main interface, if you select “Setup”, and the following interface will be displayed:

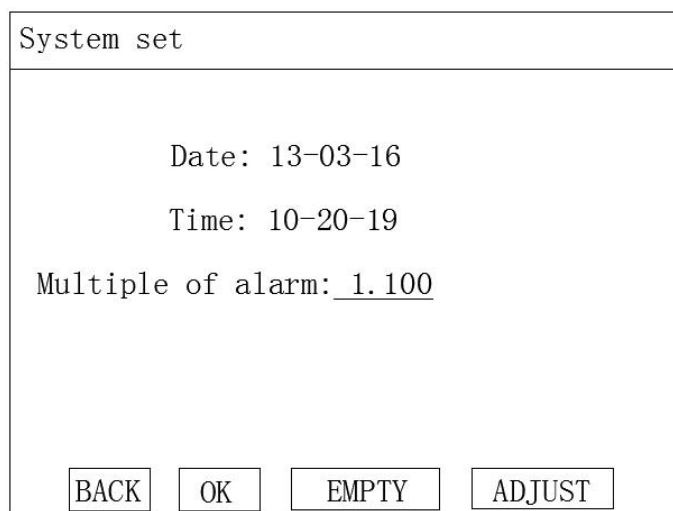
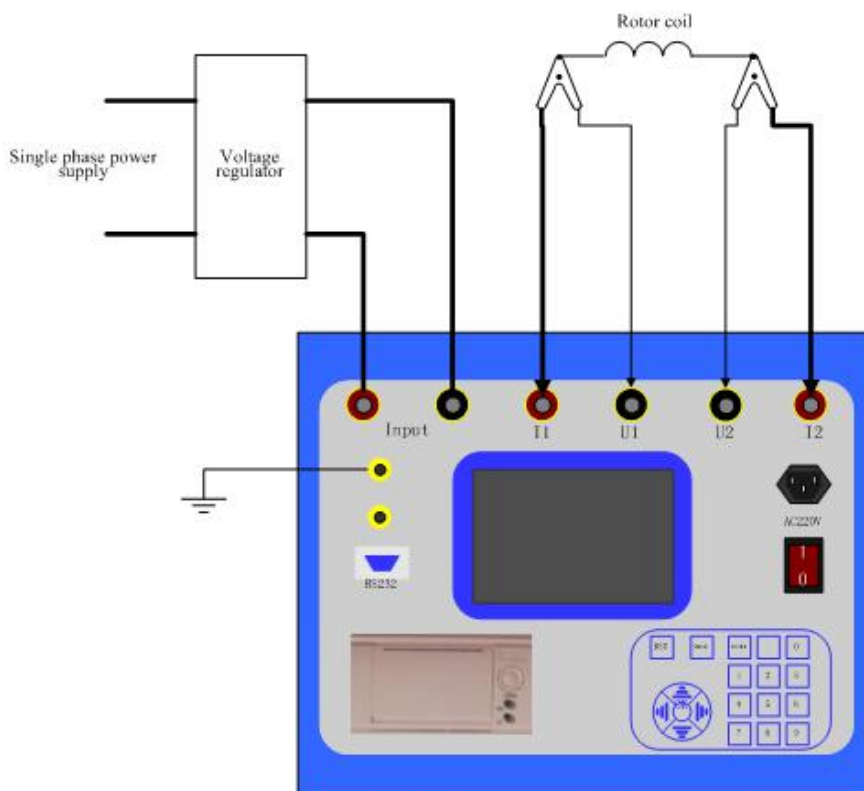

Fig. 11 Interface of System Setting

The date and time of the system can be modified in the above figure. In the above figure, the “Multiple of alarm” value is used to set the multiple relative to the maximum test voltage and maximum test current for over-voltage and over-current warning.

VI、Wiring Diagram



VII、 Precautions for Use

1. Before the use of the Tester, do carefully read the Manual and grasp the correct use method.
2. Do connect the wires properly for the test. Do check that the wiring is correct and the connection is reliable before powering on the instrument.
3. In the two leads of the test clamp, the thicker one is the current line (I1, I2) and the thinner one is the voltage line (U1, U2). The instrument adopts the dedicated high current quick coupling which should be slightly rotated when being inserted and unplugged.
4. Do operate the instrument correctly. During the test, the voltage regulator should increase the voltage slowly near the test point to ensure that the acquired data are reliable.
5. In case of abnormality during the test, you must power off the instrument, find out the causes and remove the abnormality before continuing the test. Do not operate the instrument blindly to avoid unnecessary loss.

VIII、 Common Trouble Shooting

1. No display after the instrument is switched on: you can firstly switch off the instrument, open the fuse block of the AC 220V socket on the panel, and check whether the fuse is burnt out or not; if necessary, you can replace the fuse.
2. The screen becomes blank suddenly: you can press the “Reset” key and restart the measurement.

IX、 Packing List

No.	Name	Type	Qty
1	Host	ZXFZ-H	1
2	Power cable	250V/10A/1.5m	1
3	Testing line		1
4	printer paper		2
5	Wire package		1
6	Fuse		/
7	Ground wire		1
8	manual		1
9	Test Report		1
10	Certificate/Warranty Card		1