

**ZXC38 Water-cooled
Generator Insulation
Tester(2500V)**



Contents

| | |
|--------------------------------|--------|
| I 、 Product Overview..... | - 2 - |
| II 、 Main Features..... | - 2 - |
| III、 Technical Index..... | - 4 - |
| IV、 Wiring Method..... | - 4 - |
| V 、 Operation Method..... | - 5 - |
| VI、 View Storage..... | - 10 - |
| VII、 Modify Date And Time..... | - 11 - |
| VIII、 working principle..... | - 13 - |
| IX、 Packing List..... | - 14 - |
| Appendix A..... | - 15 - |

I 、 Product Overview

This instrument is dedicated to the measurement test of internal water-cooled generators, and can also be used in the laboratory or on-site for insulation testing. The output current is greater than 25mA. The maximum output voltage is 2500V. Contains high-precision micro-current measurement system and digital boost system. Only need to use a high-voltage line and a signal line to connect the sample to measure. The measurement is carried out automatically, and the result is displayed by the large-screen LCD, and the result is stored.

II 、 Main Features

1. Using 32-bit micro-controller control, full Chinese operation interface, easy to operate.
2. The output current is large, (the output is greater than 25mA at 2500V), and the short-circuit current is $\geq 25\text{mA}$.
3. The high-voltage generating module adopts fully enclosed technology, with protective resistance inside, which is safe and reliable.
4. Strong anti-interference ability, can meet the on-site operation of ultra-high voltage substation.
5. Automatic discharge after the test, and real-time monitoring of the discharge process.
6. It is suitable for measuring the insulation resistance, absorption ratio (R60S/R15S) and polarization index (R10min/R1min) of water-cooled

generators.

7. The test high voltage is 2500V, and the insulation resistance can be measured up to 20GΩ.
8. Automatically compensate and adjust the water polarization potential. The resistance between the base and the water collection pipe is as small as 10kΩ to ensure measurement accuracy.
9. The output power is large, and the load resistance between the line and the water collection pipe can be as low as 100kΩ (2500V), and the insulation resistance can be measured as low as 1MΩ (2500V).
10. The insulation resistance value is indicated by the simulation progress bar, and the test process of the capacitive sample can be observed intuitively and without delay. Logarithmic scale, small fluctuation of displayed value, convenient reading.
11. Digital display adopts 3 ½ LCD digital meter.
12. The LCD timer displays the test time, and displays the minutes and seconds in a cycle of 0 to 32 minutes. The buzzer will sound every 15 seconds.
13. It can automatically measure and memorize R15S, R60S, R10min, absorption ratio and polarization index for review and reading when the test is completed.
14. With automatic compensation and adjustment function of water polarization potential.

III、 Technical Index

1. Accuracy: $\pm 5\%$
2. Measuring range: 0.1M~200G Ω
3. Display mode: dual display of digital and analog progress bars.
4. Temperature measurement: $-25^{\circ}\text{C} \sim 125^{\circ}\text{C}$
5. Test voltage: 2.5kV
6. Short circuit current: $\geq 25\text{mA}$
Measuring time: 1 minute to 10 minutes (with the measurement related)
7. Power Supply: 180 ~ 270VAC, 50Hz/60Hz $\pm 1\%$ (utility or generator power)
8. Working Environment
 - 1) Temperature $-10 \sim 40^{\circ}\text{C}$
 - 2) relative humidity 20 to 80%

IV、 Wiring Method

1. L terminal: "L" is the high-voltage output terminal, called the line terminal, which is led from the high-voltage cable to the terminal under test, such as connected to the motor winding and the cable core.
2. G terminal: "G" is called the shield terminal, which is used to measure the volume resistance of insulating materials or cables with the three-electrode method. It is connected to the three-electrode guard ring end.
3. E terminal: "E" is called the ground terminal and is connected to the ground and zero terminal of the measured object. For example, motor shell metal, transformer core, cable shielding layer.
4. Precautions and others Please pay attention to safety, L is the high voltage

end! E is the end of the ground and must be connected to the ground!

V、 Operation Method

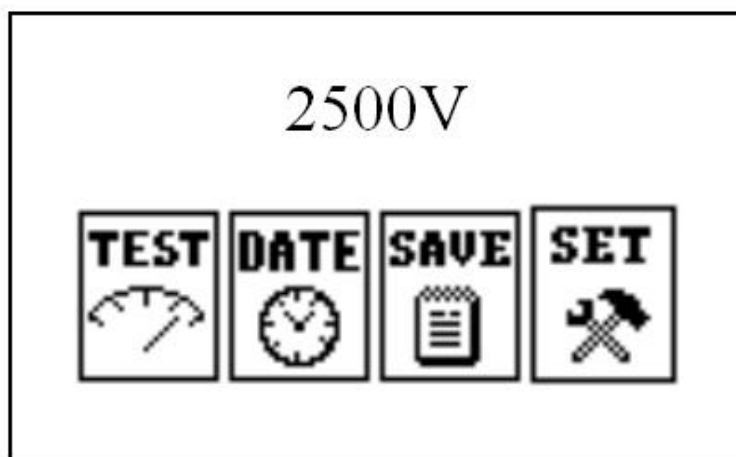

Initial setup screen (Figure 1)

1. Figure 1 shows the insulation resistance test. The test voltage is 2500V. Press the start/stop button to start the measurement.

- 1) Voltage selection key: select test voltage, range 250V, 500V, 1000V, 2500V
- 2) Function selection keys: cycle selection, insulation resistance test, view stored data, adjust date and time.
- 3) Start/stop key: start measurement and display the insulation resistance measurement screen (Figure 2)



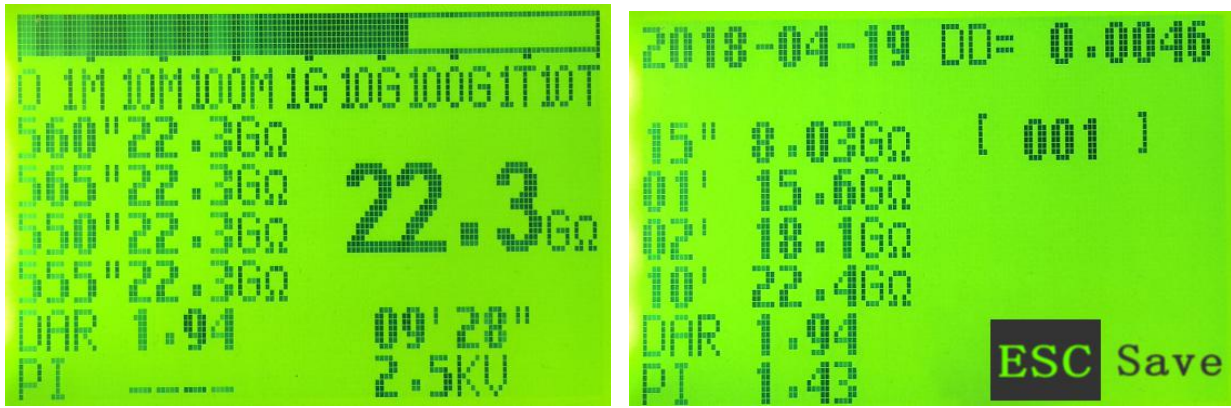

Resistance measurement (Figure 2)

- ① 2.5kV: indicates the test voltage
- ② 6G: indicates the instantaneous value of the measurement
- ③ 00'23": indicates the time in the measurement process
- ④ 560": Indicates the resistance value measured for 560 seconds
- ⑤ 565": Indicates the resistance value measured for 565 seconds
- ⑥ 23": Represents the value of 15 seconds
- ⑦ 01': indicates the value measured for 1 minute
- ⑧ 10': indicates the value measured for 10 minutes
- ⑨ DAR: Represents the absorption ratio
- ⑩ PI: indicates the polarization index
- ⑪ DD: indicates the insulation discharge rate

2. If you want PI and DD, please let the instrument finish the test and wait until the test time reaches 10 minutes, the instrument will automatically calculate PI. Then start to automatically test DD, display DD test (Figure 3)

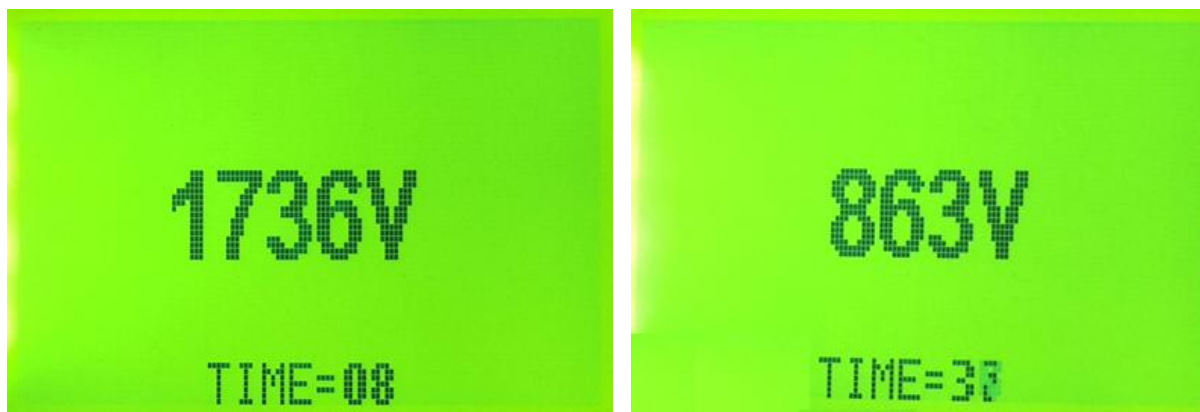

DD test (Figure 3)

During the DD test, the test voltage is always detected and timed automatically. TIME=08 is the timer. When the timer reaches 60 seconds, the DD test is complete. After the test, the instrument automatically discharges and displays the instantaneous voltage during 121V discharge.



Discharge (Figure 4)

3. After the discharge is completed, because the start/stop button has not been released, a prompt screen will be displayed. At this time, if the start/stop button is released, the measurement result will be stored (Figure 5)



Measurement result storage (Figure 5)

4. If the start/stop button is released during the measurement, the measurement is over and discharge is displayed (Figure 6)



Discharge (Figure 6)

- ① The instantaneous voltage of 121V discharge. Do not touch the test product and the measuring line at this time! Wait for the discharge to complete.
- ② The instrument adopts a special fast discharge circuit, and the discharge speed is very fast. The discharge time of 1uF capacitive sample is only about 3 seconds, so it is recommended to let the instrument discharge automatically.
- ③ After the discharge is completed, the user can manually discharge the sample if necessary.

5. After the discharge is completed, enter the measurement result storage (Figure 7)



Measurement result storage (Figure 7)

2018-04-19 is the current storage date

15": Means measuring 15 seconds value

01': Indicates the value of 1 minute of measurement

02': Indicates the value of 2 minutes of measurement

10': indicates the value of measuring 10 points

DAR: Represents the absorption ratio

PI: Represents the polarization index

DD: indicates the insulation discharge rate

[001]: indicates the serial number of measurement data storage

6. Operation in the state of measurement result storage (Figure 7).

① Press the → function selection key to make the (exit, store, 001) cycle selected.

② Press the OK button to return to the insulation resistance test when exiting in the selected state (Figure 1)

③ When 001 is in the selected state, press the → function selection

key to move the position, and press the $\uparrow\downarrow$ key to modify the serial number.

- ④ When exit is in the selected state, press the OK key to save the current data, and the cursor returns to exit.
- ⑤ When exit is in the selected state, press the \uparrow to increase key to display the test data and waveform graph in a loop. As shown in Figure 8.

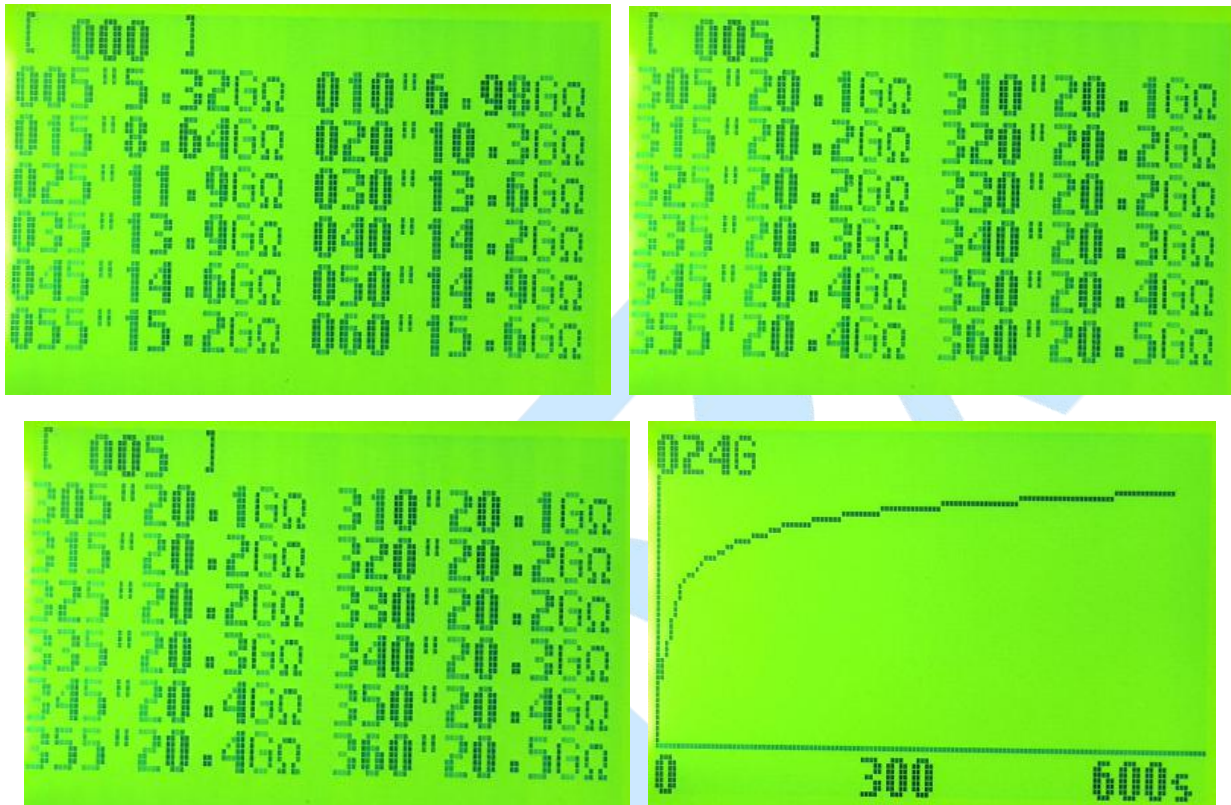
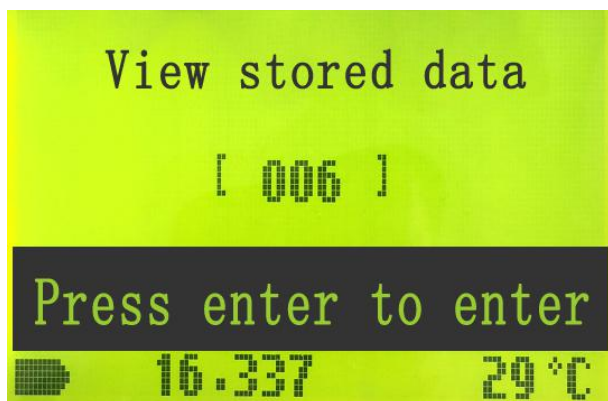

Figure 8

- ⑥ After recording the test data, if you want to exit immediately. You can press (Start/Stop button) to exit. After exiting the data screen, the instrument will prompt you to release (Start/Stop key), when you release (Start/Stop key), the instrument enters the insulation resistance test (Figure 1).

VI、 View Storage

1. Press (function selection key) to select to view stored data



View storage data (Figure 9)

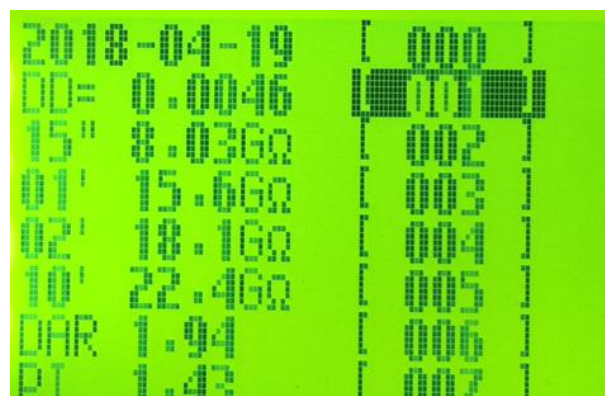

Display stored data (Figure 10)

2018-04-19 is the current storage date

15": Means measuring 15 seconds value

01': Indicates the value of 1 minute of measurement

02': Indicates the value of 2 minutes of measurement

10': indicates the value of measuring 10 points

DAR: Represents the absorption ratio

PI: Represents the polarization index

DD: indicates the insulation discharge rate

[001]: indicates the serial number of measurement data storage

2. 000 to 007 indicate measurement serial number

3. Press the increase/decrease key to make 000 to 007 in the selected state and display the data of this serial number.

4. Press the function selection key to turn pages.

5. Press the OK button to return to view the stored data (Figure 9)

VII、Modify Date And Time

1. Press (function selection key) to select to adjust the date and time



Adjust the date and time (Figure 11)

2. Press (OK) to enter the date and clock adjustment (Figure 12)



Date and clock adjustment (Figure 12)

3. Press the function selection key to make the (exit, set) cycle in the selected state.
4. If the cursor is on exit, press the OK key to return to the date and time adjustment screen (Figure 11).
5. If the cursor is on the setting, press the OK key to move the cursor to the

date and clock number.

6. With the cursor on the date and clock, press the up/down key to change the clock number.
7. Press the function selection key to select the date and clock digital cycle.
8. If the cursor is on the clock number, press the OK key, after adjusting the clock, the cursor returns to exit.

VIII、 working principle

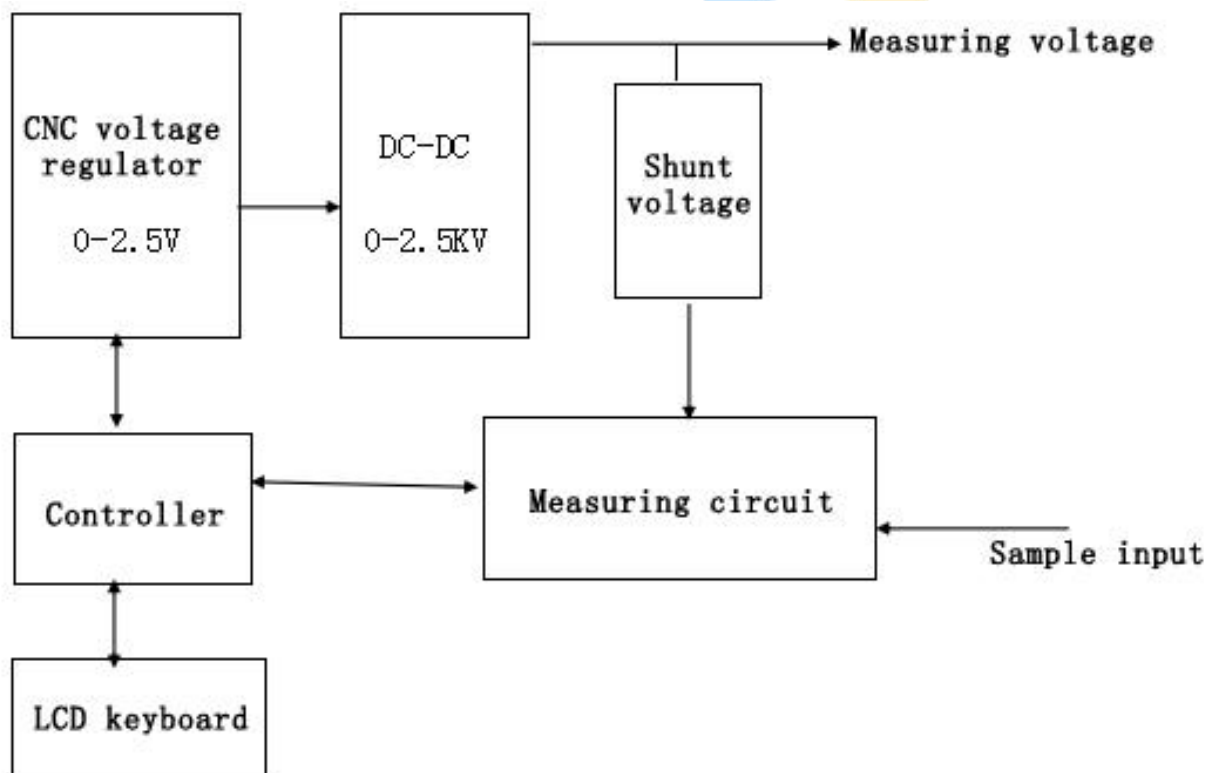

Functions of each part

- 1) LCD keyboard: responsible for keyboard and display.
- 2) Numerically controlled voltage regulator: adopts PWM circuit to produce 0-5V standard output with high efficiency.
- 3) DC-DC 0-2.5kV: using step-up transformer, efficient conversion, output 0-2.5kV DC high voltage. With short circuit protection function

-
- 4) Voltage divider circuit: 0-2.5kV high voltage, converted into 0-2.5V, convenient for AD collection.
 - 5) Measuring circuit: responsible for data acquisition, current conversion, etc.
 - 6) Controller: Connect all the above modules to complete the measurement.

IX、 Packing List

| NO. | Name | Qty |
|-----|---------------------------|-----|
| 1 | Host | 1 |
| 2 | HV line | 1 |
| 3 | Ground wire | 1 |
| 5 | charger | 1 |
| 6 | manual | 1 |
| 7 | Test Report | 1 |
| 8 | Certificate/Warranty Card | 1 |

Appendix A

1. The main factors affecting resistance or resistivity testing

1) Ambient temperature and humidity

The resistance value of general materials decreases with the increase of environmental temperature and humidity. Relatively speaking, surface resistivity (rate) is more sensitive to environmental humidity, while volume resistivity (rate) is more sensitive to temperature. As humidity increases, surface leakage increases, and body electrical current will increase. As the temperature rises, the speed of carrier movement speeds up, and the absorption current and electrical conduction current of the dielectric material increase accordingly. According to relevant data, the resistance value of the general dielectric at 70° is only 10% of that at 20°. Therefore, when measuring the resistance of a material, it is necessary to specify the temperature and humidity at which the sample and the environment are in equilibrium.

2) Test voltage (electric field strength)

The resistivity (rate) value of the dielectric material generally cannot remain unchanged in a wide voltage range, that is, Ohm's law does not apply to this. Under normal temperature conditions, in the lower voltage range, the electrical conduction current increases linearly with the increase of the applied voltage, and the resistance value of the material remains unchanged. After a certain voltage is exceeded, due to the intensified ionization movement, the electrical conduction current increases much faster than the test voltage, and the resistance value of the material decreases rapidly. It can be seen that the

higher the applied test voltage, the lower the resistance value of the material, so that the resistance value of the material tested under different voltages may have a greater difference.

It is worth noting that the decisive factor leading to the change of the resistance value of the material is the electric field strength during the test, not the test voltage. For the same test voltage, if the distance between the test electrodes is different, the test results of the material resistivity will also be different. The smaller the distance between the positive and negative electrodes, the smaller the test value.

3) Test time

When a certain DC voltage is applied to the tested material, the current on the tested material does not reach a stable value instantaneously, but has a decay process. While pressurizing, a larger charging current flows, followed by a slower absorption current for a longer period of time, and finally a relatively stable electrical conduction current. The higher the measured resistance value, the longer it takes to reach equilibrium. Therefore, in order to correctly read the measured resistance value during measurement, the value should be read after stabilization or the reading value after 1 minute of pressure should be taken.

In addition, the resistance value of a high-insulation material is also related to its charging history. In order to accurately evaluate the electrostatic properties of the material, when testing the electrical resistance (rate) of the material, the material should first be dissipated and left to stand for a certain

period of time. The standing time can be 5 minutes, and then test according to the measurement procedure. Generally speaking, for a material test, at least 3 to 5 samples should be randomly selected for testing, and the average value is used as the test result.

4) Leakage of test equipment

In the test, the wires with low insulation resistance in the circuit are often inappropriately connected in parallel with the tested sample, sampling resistance, etc., which may have a greater impact on the measurement results. to this end:

In order to reduce the measurement error, protection technology should be adopted, and protective conductors should be installed on the lines with large leakage current to basically eliminate the influence of stray current on the test results;

Due to surface ionization of high-voltage lines, there is a certain amount of leakage to the ground, so try to use high-insulation, large-diameter high-voltage wires as high-voltage output lines and shorten the connections as much as possible, reduce the tip, and prevent corona discharge;

Use insulating materials such as polyethylene and polytetrafluoroethylene to make the test bench and support to avoid low test values due to such reasons.

5) External interference

After the high-insulation material is applied with a DC voltage, the current passing through the sample is very small, and it is extremely susceptible to the

influence of external interference, resulting in larger test errors. The thermoelectric potential and contact potential are generally very small and can be ignored; the electrolytic potential is mainly generated by the contact of the wet sample with different metals, only about 20mV, and in the electrostatic test, the relative humidity is required to be low. When testing in a dry environment, Eliminate electrolysis potential. Therefore, the external interference is mainly the coupling of stray current or the potential generated by electrostatic induction. When the test current is less than 10-10A or the measurement resistance exceeds 10¹¹ ohms; strict shielding measures should be taken for the tested sample, test electrode and test system to eliminate the influence of external interference.