

ZXHQ-B+
CT/PT Analyzer



Contents

I、 Product Overview.....	- 2 -
II、 Characteristic.....	- 2 -
III、 Panel Introduction.....	- 2 -
IV、 Technical Parameter.....	- 3 -
V、 Method Of Operation.....	- 4 -
1. Current Transformer.....	- 4 -
1) Test connection.....	- 4 -
2) Parameter Setting.....	- 5 -
3) Test Results.....	- 9 -
2. Voltage Transformer Test.....	- 12 -
1) Test Connection.....	- 12 -
2) Parameter Setting.....	- 13 -
3) Test Results.....	- 14 -
3. Self-Test Page.....	- 15 -
1) Parameter Setting.....	- 15 -
2) Wiring Method.....	- 15 -
4. Function Button.....	- 16 -
1) Parameter Page Function Button.....	- 16 -
2) Result Page Function Button.....	- 17 -
VI、 Packing list.....	- 18 -
Appendix.....	- 20 -
A. Principle Of Low-Frequency Test.....	- 20 -
B. 10% Error Curve.....	- 21 -
C. Actual Connection Method.....	- 22 -
D. Four-Terminal Method Of Measuring Principle Wiring.....	- 24 -

I 、 Product Overview

ZXHQ-B+ CT/PT Analyzer is new product created after widely adopt customers' advices and deep theoretical study. The series of product equipped with high-performance DSP and ARM, advanced manufacturing technology ensured a stable and reliable product performance, full-featured, high degree of automation, high efficiency, leading in the market. They are the professional testing equipments for instrument transformer check in power industry.

II 、 Characteristic

1. Full-featured, not only satisfy the test requirements of various CTs (include TP class), such as the excitation characteristics (i.e., volt-ampere characteristics), ratio, polarity, secondary winding resistance, secondary burden, ratio error and phase displacement, but can also be used for the tests of various PTs, including excitation characteristics of the electromagnetic unit, ratio, polarity, secondary winding resistance, ratio error and phase displacement.
2. Automatically give CT, VT parameters, including knee point voltage / current, 10% error curve, the accuracy limit factor (ALF), instrument security factor (FS), the second time constant (Ts), remanence coefficient (Kr), saturated and unsaturated inductance etc.
3. Test meet IEC60044 GB1208 (-1) GB16847 (IEC60044-6) became etc all kinds of transformer standards, and in accordance with the transformer types and levels of automatic choose which standard test
4. Based on advanced principle of low-frequency test method that can meet the CT test on knee voltage up to 60KV.
5. Friendly interface beautiful, all English graphic interface
6. The instrument can store 1000 groups of test data that won't be lost when power off. After test ended, the data can be copied to PC by USB disk for analysis and being transformed into WORD report.
7. Test is simple and convenient; one-click can complete tests of CT secondary resistance, excitation, ratio and polarity.
8. Easy to carry, because the weight is less than 10Kg.

III、 Panel Introduction

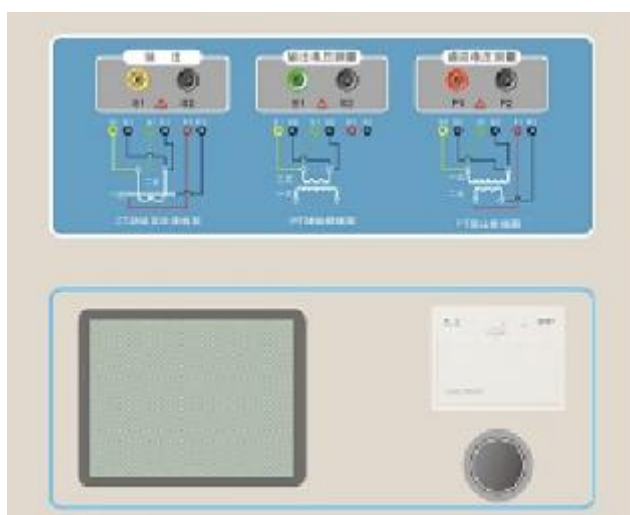

- a. Yellow K1, black K2 terminal: test power output
- b. Green S1, black S2 terminal: measure output voltage
- c. Red P1, black P2 terminal: measure inductive voltage
- d. Keyboard: Enter the value and operational command
- e. LCD screen: GUI

IV、 Technical Parameter

Usage		CT, PT
Output		0~180Vrms, 12Arms, 36A (peak value)
Voltage measurement accuracy		±0.2%
CT Ratio	Range	1~40000
	Accuracy	±0.1%
PT Ratio	Range	1~40000
	Accuracy	±0.1%
Phase	Range	±2min
	Accuracy	0.5min
DC resistance	Range	0~300Ω
	Accuracy	0.2%±2mΩ
Burden	Range	0~1000VA
	Accuracy	0.2%±0.02VA
Power supply		AC220V±10%, 50Hz
Environmental Conditions		Operating temperature:-10℃~50℃ Humidity :≤90%
Weight and Dimensions		Dimensions: 365 mm×290 mm×153mm, Weight<10kg

V、 Method Of Operation

1. Current Transformer

In Para interface, use the Rotating mouse to switch cursor in transformer type frame, and then choose the current transformer (CT).

1) Test connection

Used for selecting one or more experiment item, including four options such as resistance, excitation, ratio, burden etc. According to transformer type, four options can be combined as shown in below table.

Table 1 CT experiment project description							
experiment item						Description	Connection diagram
resistance	excitation	ratio	error	limit	burden		
√						Measure CT's secondary winding resistance	Fig 1, can disconnection if measuring primary winding.
√	√					Measure CT's secondary winding resistance and excitation characteristic	Fig 1, can disconnection if measuring primary winding.
√		√	√			Measure CT's secondary winding resistance, check it's ratio and polarity	Fig 1
√	√	√	√	√		Measure CT's secondary winding resistance and excitation characteristic, check it's ratio and polarity	Fig 1

					√	Measure CT's secondary burden	Fig 2
--	--	--	--	--	---	-------------------------------	-------

Note: The ‘√’ means valid, and the blank means invalid

Step:

Step1. According to the CT testing project description of the table 2.1 to wiring (For all the CT structures, please refer to the description of appendix D for the actual connection mode)

Step 2. The other windings of the same CT should be opened; CT's primary side to grounding, equipment should be also to ground

Step 3. Power on and prepare parameters Settings.

Step 4. Then switch cursor to the “start” button to start

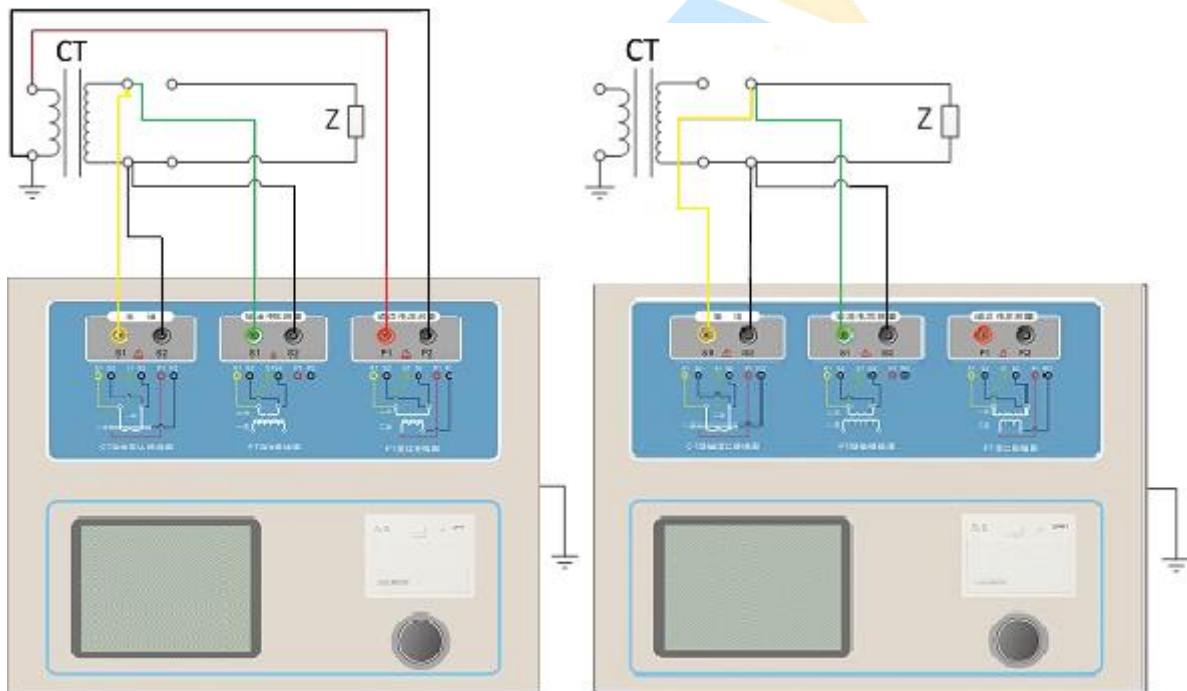

Fig 1 DC resistance, excitation, ratio experiment connection

Fig 2 Secondary load experiment connection

2) Parameter Setting

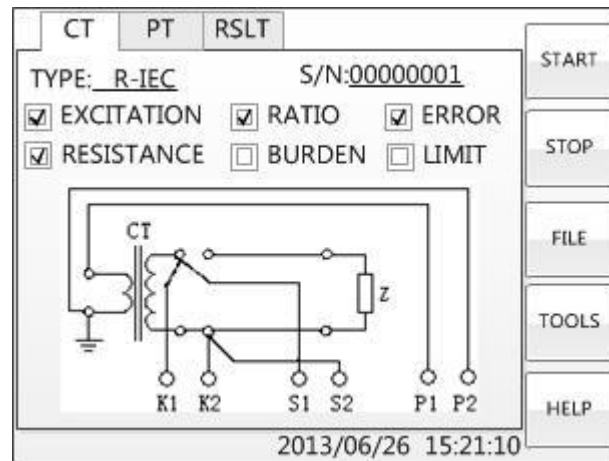

Fig 2.3 Basic parameter Settings interface

parameter Settings:

Switch cursor to where the parameter you want to set by turning the Rotating mouse

- ① Serial number and resistance number: Input letters and numbers, the filename default saved is “CT_ numbers _ winding number.ctp”
- ② Rated secondary current I_{sn} : The current transformer’s secondary rated current is 1A or 5A generally.
- ③ Class: For CT, there’re 8 options for Measured winding class, they are P, TPY, metering, PR, PX, TPS, TPX and TPZ etc.
- ④ Current temperature: When measure the temperature of winding, generally input the current room temperature for reference.
- ⑤ Rated frequency: 50Hz or 60Hz
- ⑥ Maximum measured current: Can be generally set to rated secondary current value. For TPY class, can be generally set to 2 times rated secondary current value. For P class, assumed 5P40, rated secondary current is 5A, so the maximum should be set to $10\% \cdot 15 \cdot 5A = 7.5A$

If user want to measure the bellowing items, user need to set the basic parameters accurately (Suggest user setting himself)

- ① Turn ratio error, ratio error and phase error
- ② Accurately calculate the limit e.m. f and their corresponding compound error
- ③ Measured accurately limit coefficient, Instrument security coefficient and symmetrical short-circuit current multiples

④ The measured transient dimensioning coefficient, peak transient error and second time constant

For different CT, different parameters should be set. Details as table 2

Table 2 CT parameter description									
parameters	description	R-IEC R-ANS I	TP Y	M-IE C M-AN SI	P R	P X	TP S	TP X	TP Z
rated primary current	Used to calculate the ratio of actual current accurately	√	√	√	√	√	√	√	√
rated burden	Rated load of plate, power factor for 0.8 or 1	√	√	√	√	√	√	√	√
power factor		√	√	√	√	√	√	√	√
Rated accurate limit coefficient K_{alf}	The provisions of the plate, default 10, used to calculate the limit e.m.f. and their corresponding composite error	√							
Rated symmetric short-circuit current coefficient K_{ssc}	The provisions of the plate, default 10, used to calculate the peak and their corresponding limits e.m.f transient error		√				√	√	√
Primary time constant	default :100ms		√					√	√
Second time constant	default :3000ms		√						√
Duty cycle	C-t1-O or C-t1-O-tfr-C-t2-O, default:C-t1-O cycle		√					√	
t1	Current time limit for the first time,default:100ms		√					√	
tal1	Time required to reach the specified accuracy during the								

	first magnetization cycle,default:40ms								
tfr	Time required to reach the specified accuracy during the second magnetization cycle,default:500ms, Choose C-t1-O-tfr-C-t2-O,Cycle will be shown		√					√	
t2	Current time limit for the second time,default:100ms.C choose C-t1-O-tfr-C-t2-O,Cycle will be shown		√		√			√	
tal2	Second the flow by maintaining accurate limits of time,default:40ms choose C-t1-O-tfr-C-t2-O,cycle will be shown		√					√	
Rated instrument security coefficient FS	Nameplate regulation,default:10 Used for calculation of the limit of composite error and their corresponding electromotive force			√					
Rated calculating coefficients						√			
Rated inflection point potential(Ek)						√			
le correspondin g with Ek						√			
dimensioning factor							√		

	resistance (75°C)	R_{ref} , unit: Ω , Convert to resistance under 75°C	√	√	√	√	√	√	√	√
excitation	knee voltage and knee current	unit:V and A, According to standard definition, when knee voltage increase 10%,knee current increase 50%.	√	√	√	√	√	√	√	√
	Unsaturated inductance L_u	unit:H,The average inductance of linear section for excitation curve	√	√	√	√	√	√	√	√
	remanence coefficient K_r	ratio of magnetism and magnetic	√	√	√	√	√	√	√	√
	Second time constant T_s	unit: s,the time constant of CT's second connect rated burden	√	√	√	√	√	√	√	√
	limiting e.m.f E_{at}	unit:V,calculation limit e.m.f. according to the CT nameplate and resistance under 75°C	√	√	√	√			√	√
	composite error E_{at}	limiting e.m.f or the composite error of rated knee potential	√		√	√	√			
	Peak transient error ε	Peak transient error of limiting e.m.f		√					√	√
	ALF	actual ALF	√			√				
	Instrument security coefficient	actual instrument security coefficient			√					

	Symmetrical short-circuit current multiples K_{ssc}	actual symmetrical short-circuit current multiples		√				√	√	√
	transient dimensioning factor	actual transient dimensioning factor		√					√	√
	calculated coefficient K_x	actual calculated coefficient					√			
	Rated knee potential E_k						√			
	I_e corresponding with E_k	The actual excitation current corresponding with rated knee potential					√			
	Rated voltage U_{al}	The rated equivalent second limit voltage						√		
	I_{al} corresponding with U_{al}	The actual excitation current corresponding with the rated equivalent second limit voltage						√		
Ratio	Ratio	Actual current ratio under rated burden	√	√	√	√	√	√	√	√
	Turns ratio	The ratio of actual secondary winding and primary winding	√	√	√	√	√	√	√	√
	Ratio difference	The current errors under rated load	√	√	√	√	√	√	√	√
	Phase difference	The D-value of phase under rated load	√	√	√	√	√	√	√	√
	Polarity	There're two polarity relationship for primary CT and secondary CT: Positive and Negative	√	√	√	√	√	√	√	√
	Turn ratio error	The relative error between measured turn ratio and rated turn ratio					√	√		

Note: "√" expressed the need for settings that do not need to set up a blank

2. Voltage Transformer Test

1) Test Connection

Used for selecting one or more experiment item, including three options such as resistance, excitation, ratio etc. According to transformer type, three options can be combined as shown in table 4.

experiment item				Description	Connection diagram
resistance	excitation	ratio	burden		
√				Measure PT's secondary winding resistance	Fig 5, must disconnection if measuring primary winding.
√	√			Measure PT's secondary winding resistance and excitation characteristic	Fig 5, must disconnection if measuring primary winding.
		√		Check it's ratio and polarity	Fig 6
			√	Measure PT's secondary burden	

In **Para** interface, use the **Rotating mouse** to switch cursor in transformer type frame, then choose PT.

Experimental wiring procedure is as follows:

Step 1. According to PT testing program description of list 4, refer to figure 5 or figure 6 for wiring

Step 2. The other windings of the same CT should be opened

Step 3. Power on and prepare parameters Settings.

Step 4. Then switch cursor to the "start" button to start

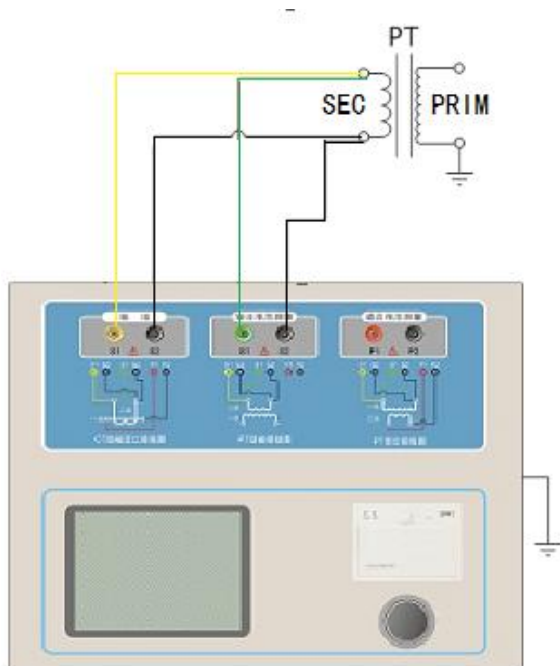

Fig 5 PT's DC resistance and excitation

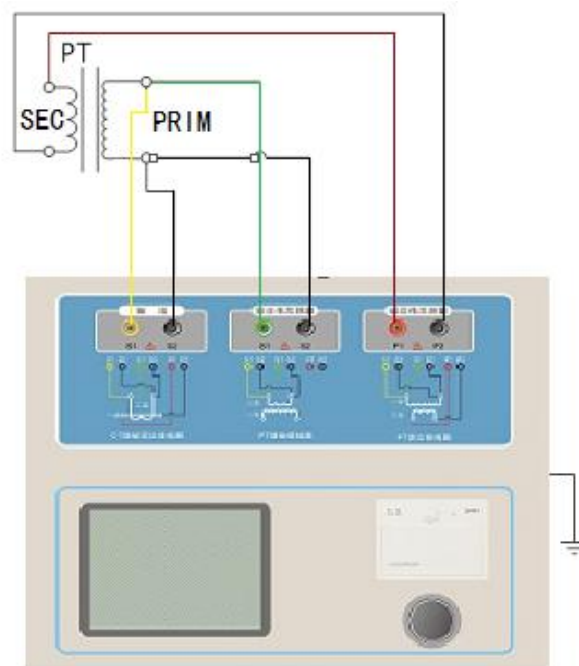

Fig 6 PT's ratio and excitation

2) Parameter Setting

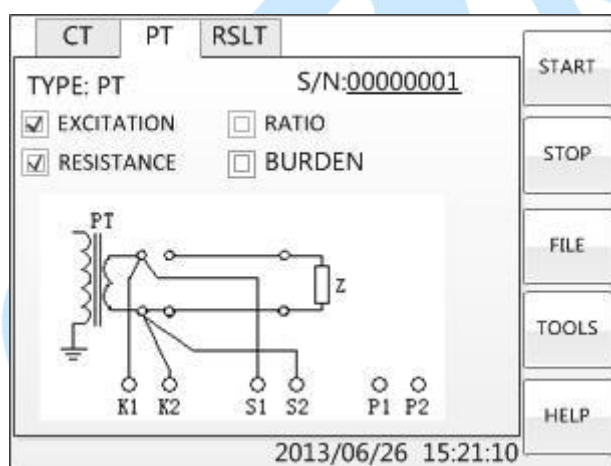

Fig 7 PT parameter establish interface

parameter Settings:

Switch cursor to where the parameter you want to set by turning the **Rotating mouse**

- ① Serial number and resistance number: Input letters and numbers directly
- ② Rated secondary voltage V_{sn} : Secondary rated voltage of Voltage transformer
- ③ Class: For CT, there're 2 options for Measured winding class, they are P and metering etc.
- ④ Current temperature: When measure the temperature of winding, generally input the current room temperature for reference.

⑤ Rated frequency: 50Hz or 60Hz

⑥ Maximum test voltage: The equivalent voltage under the maximum frequency of output while testing

⑦ Maximum test current: The maximum AC current of output while testing

3) Test Results

Test results interface as shown in Fig 8

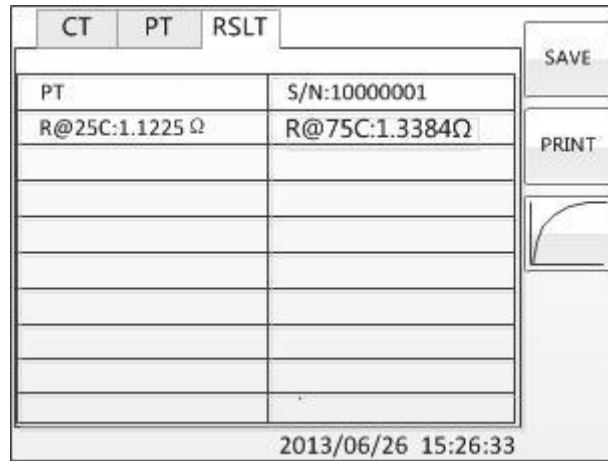

Fig 8 PT's test results interface

According to different voltage transformer type and experiment item, the results will be also different. The detailed as shown in Table 5.

Table 5 PT test results description				
	result	description	P	M
Resistance	resistance (25°C) R	unit : Ω , resistance value under current temperature	√	√
	resistance (75°C) R_{ref}	unit : Ω ,Resistance value under reference temperature(the temperature is variable)	√	√
excitation	knee voltage and knee current	unit:V and A , According to standard definition , when knee voltage increase 10%,knee current increase 50%.	√	√
Ratio	Ratio	Actual current ratio under rated burden	√	√
	Turns ratio	The ratio of actual secondary winding and primary winding	√	√
	Ratio difference	The current errors under rated load	√	√

	Phase difference	The D-value of phase under rated load	√	√
	Polarity	There're two polarity relationship for primary and secondary , Positive and Negative	√	√

3. Self-Test Page

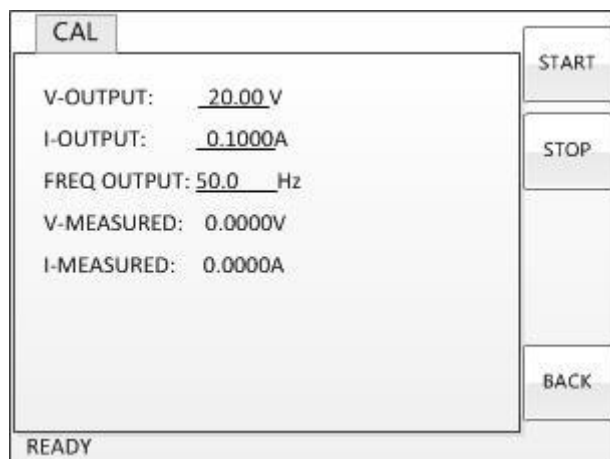

Fig 9 Self-test interface

1) Parameter Setting

The required self-test parameters are shown in the table 6:

Parameter	description
Test current	The need for device output current, valid value range: 1mA ~ 5A
Test voltage	The need for device output voltage, valid value range: 1V~100V
est. frequency	Installation of the output voltage or current frequency, scope: 0 ~ 50Hz

After testing Current test set or test voltage, set the test frequency, the frequency of the device will output the corresponding voltage or current, to detect and display the actual voltage or current. In the choice of voltage, if the burden is too small, resulting in greater than the actual current RMS 5A, show that information overburden. In the selection of current, if the burden too much, leading to the actual test voltage RMS is greater than 100V, it will display information overburden.

2) Wiring Method

① When Choosing voltage tests, the two terminals will be short-S1 Then, S2 shorted the two terminals. Use multimeter to get the voltage value between S1 and S2, if the value

is the same with actual voltage of instrument, it is OK.

② When Choosing Current test, the shorted output S1, S2 terminals. Do not take the wrong attention. Series connecting a multimeter between S1 and S2, if the current value of multimeter is the same with actual current of instrument, it is OK.

4. Function Button

1) Parameter Page Function Button

- ① Open a report

The interface of opening a report is shown in Fig 10. Choose to open a report, the relative information will be displayed in corresponding column.

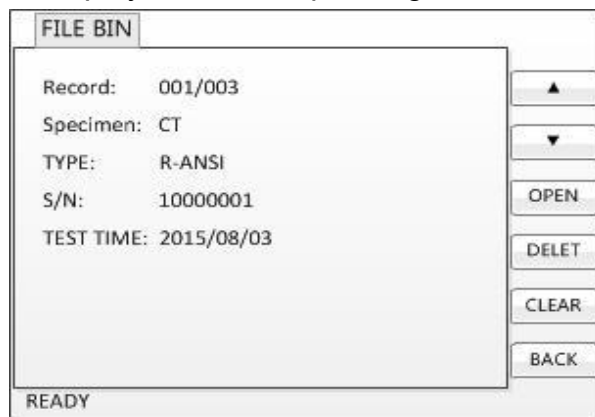

Fig 10 Open a report

- ② System Tools

The interface of system tools is shown in Fig 11. In this interface, some operations can be performed, such as time adjustment, file delete, system up gradation, etc.

- ③ Help

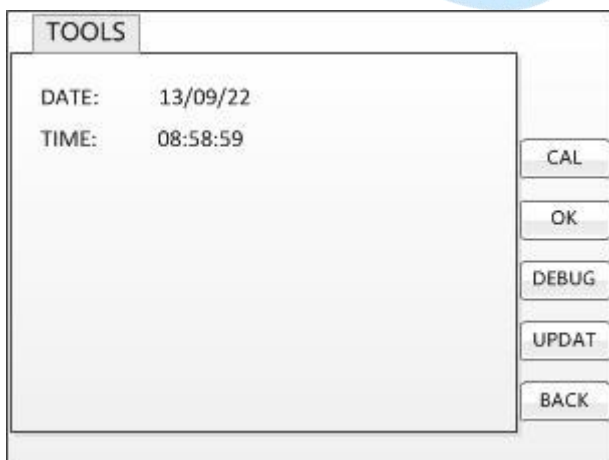

Fig 11 system tool interface

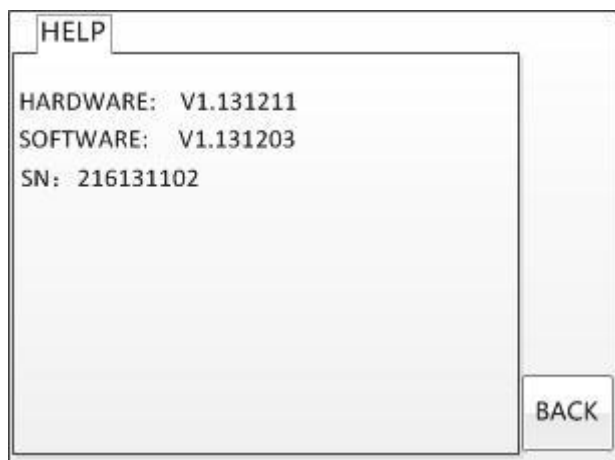

Fig 12 Help interface

2) Result Page Function Button

① Error data

Selecting the error data will show 5% and 10% error cases, the relationship of rated primary current multiple and the maximum burden is shown as Fig 13. These data is calculated according to the actual excitation. The calculation Method is given in appendix B.

Item	Z-5%	M-5%
1	20.11	3.432
2	18.32	3.996
3	17.18	4.732
4	16.21	7.128
5	5.769	9.624
6	3.451	11.37
7	1.345	14.25
8	0.614	18.96
9	0.256	6.321

2013/06/26 15:21:10

Fig 13 5% error data interface

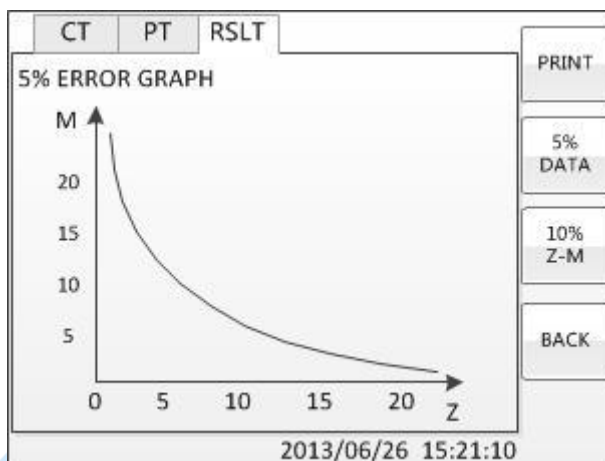

Fig 14 5% error curve interface

② Error Curve

Selecting the error curve, the relationship curve of rated primary current multiple and maximum burden will be shown as fig 14 according to 10% (or 5%) error. The x axis is rated primary current multiple; axis y is allowable maximum burden.

③ Excitation data

Selecting the excitation data, excitation data interface will be shown fig 15. In the figure, knee voltage and current is automatically calculated and shown, the user can print the date.

④ Excitation curve

Selecting Excitation curve, the excitation curve of the interface will be shown in Fig 16, knee voltage and current is given.

CT	PT	RSLT
Item	U (V)	I (A)
1	0.0039	0.0002
2	0.8344	0.0017
3	1.7184	0.0025
4	2.6419	0.0034
5	3.5864	0.0051
6	3.5914	0.0057
7	3.7928	0.0065
8	4.5094	0.0089
9	4.6514	0.01

2013/06/26 15:21:10

Fig 15 excitation data

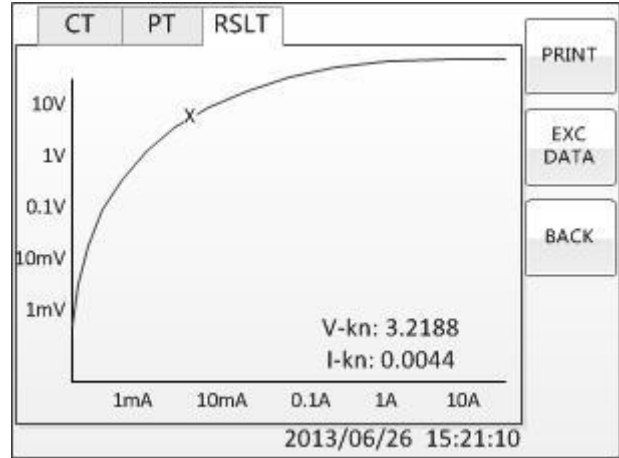

Fig 16 Excitation curve interface

⑤ Ratio page

Used for displaying the test results of ratio. Polarity, ratio error, and phase displacement as shown in fig 17.

I _{pn} (%)	VA/PF			
	5.0/0.8		1.25/0.8	
	%	(°)	%	(°)
1	-0.7	-3.07	-0.704	13.6
5	-0.07	11.9	-0.025	11.8
10	-0.034	9.64	0.003	9.59
20	-0.015	7.85	0.023	7.93
50	0.011	5.97	0.037	5.97
100	0.04	3.91	0.059	4.01
120	0.044	3.58	0.062	3.76

2013/06/26 16:21:10

Fig 17 ratio page

VI、 Packing list

NO.	Name	Model	Quantity
1	Host	ZXHQ-B	1
2	Power cord	250V/16A/1.5m	1
3	Red test line	2.5mm ² x6m	1
4	Yellow test line	2.5mm ² x6m	1
5	Green test line	2.5mm ² x6m	1
6	Ground wire	2.5mm ² x3m	1

7	Crocodile clip	12mm	4
8	Crocodile clip	20mm	2
9	U insert	6mm	4
10	Thermal printing paper		4
11	Insurance tube	20A	5
12	A special driver insurance tube	6*38mm	1
13	Aluminum alloy packing box		1
14	manual		1
15	test report		1
16	Certificate / warranty card		1

Appendix

A. Principle Of Low-Frequency Test

IEC60044-6 standard (corresponding to the national standard GB16847-1977) claims, CT test can be done in conditions lower in frequency than the rated, and avoid secondary windings the risk of failing to allow the terminal voltage. The only requirement is that the core has the same size on the magnetic flux.

IEC60044-6 standard formula for calculating the magnetic flux given by:

$$\Psi(t) = \int_0^t [U_{CT}(t) - R_{CT}I_{CT}(t)]dt + \Psi_0 \quad (\text{A.1})$$

Where,

R_{CT} : Secondary winding resistance

U_{CT} : Secondary winding terminal voltage

I_{CT} : Secondary current

Ψ_0 : The initial flux Alternation

$\Psi(t)$: T the magnetic moment of the cross-linking

The definition of Core Voltage:

$$U_C(t) = U_{CT}(t) - R_{CT}I_{CT}(t) \quad (\text{A.2})$$

When the core voltage $U_C(t)$ for the sinusoidal signal are: (A.3)

Core voltage RMS to meet:

$$U_{Crms} = \frac{\omega\Psi_m}{\sqrt{2}} = \frac{2\pi f\Psi_m}{\sqrt{2}} = 4.44 f\Psi_m \quad (\text{A.4})$$

where:

f : For the sinusoidal signal frequency

As can be seen, the largest settlement in the same chain of magnetic flux Ψ_m , the core is proportional to voltage and frequency. Therefore, as long as the core has the same size on the magnetic flux, then the test CT can be lower than the rated frequency of the conduct, when the core voltage amplitude required to reduce the requirements, test requirements of the secondary winding of the client voltage also be reduced accordingly. On the frequency

of low-frequency test results can be rated after the conversion frequency of CT test results.

B. 10% Error Curve

Current transformer error was mainly due to the existence of exciting current I_0 , which allows the secondary current I_2 and secondary lateral conversion to a current value I_1' is not only not the same, but different phase, which resulted in the error of current transformer.

The ratio of differential current transformer is defined as:

$$\varepsilon = \frac{I_1' - I_2}{I_1'} \times 100 = \frac{I_0}{I_1'} \times 100 \quad (\text{B.1})$$

Current Transformer relay request a current I_1 equal to the maximum short-circuit current, the ratio difference is less than or equal to 10%. Difference in the ratio equivalent to 10%, the secondary current I_2 , and conversion to a secondary lateral excitation current I_1' between the current I_0 and meet the following relationship:

$$I_1' = 10I_0 \quad (\text{B.2})$$

$$I_2 = 9I_0 \quad (\text{B.3})$$

Definite M as a multiple of the maximum short-circuit current, K for the current transformer ratio, there are

$$M = \frac{I_{1M}}{I_{1N}} = \frac{K \times I_1'}{K \times I_{2N}} = \frac{10I_0}{I_{2N}} \quad (\text{B.4})$$

Where

I_{1M} The largest one-side short-circuit current

I_{1N} Rated current for one side

I_{2N} Rated current for the secondary side

When Ration error is 10 percent, the maximum allowable burden impedance Z_B is calculated as:

$$Z_B = \frac{E_0}{I_2} - Z_2 = \frac{E_0}{9I_0} - Z_2 \quad (\text{B.5})$$

Where

Z_2 For the current transformer secondary winding impedance

E_0 Is Current transformer secondary winding for the induction electromotive force, and the relationship between E_0 and I_0 is the characteristic curves described by the excitation.

Based on the above formula, the final could be a multiple M of the maximum short-circuit current and burden impedance Z_B of the maximum allowable 10% error described curve (see Figure 12).

C. Actual Connection Method

ZXHQB for the CT test the basic connection steps (see Figure D.1) as follows:

- 1) 4mm² line the left side of ZXHQ-B is connected to the grounding terminal protected.
- 2) To connect a CT primary side and secondary side terminals of a terminal to protected areas.
- 3) To ensure that all the CT terminal of the other transmission lines disconnect from, all other windings open.
- 4) 2.5mm² red and black line CT secondary side connected to the ZXHQ-B "Output" K1 and K2 jack, the yellow line and 2.5mm² line CT secondary side connected to the ZXHQ-B "Sec" jack of the S1 and S2, the attention of even the two black lines in the CT secondary side has received the same protection to terminal.
- 5) Green Line and 2.5mm² lines CT is connected to a side of ZXHQ-B 's "Prim" of P1 and P2 terminal, P2 and CT through the black line is connected to the protection of one side of the terminal connected.
- 6) No problems in check wiring, to begin testing.

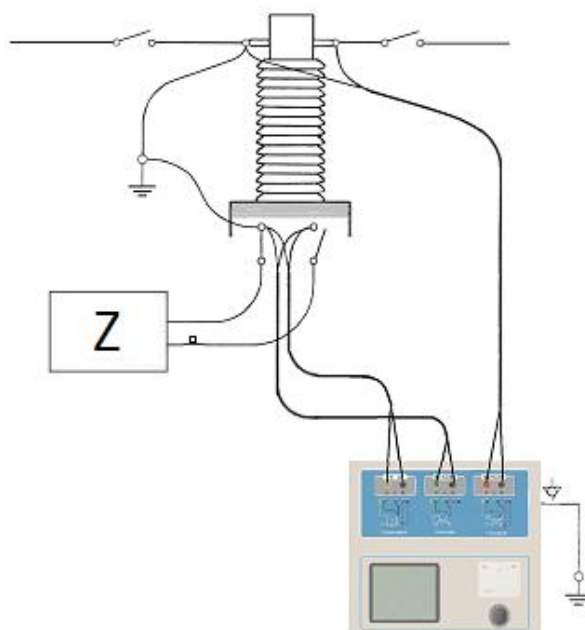

Figure D.1 Typical Connection

1. ZHXQ-B in the triangle connection transformer CT test conducted on the connection mode as shown in Figure D.2.

Figure D.2 ZHXQ-B in the triangle on the transformer connection when the connection mode test

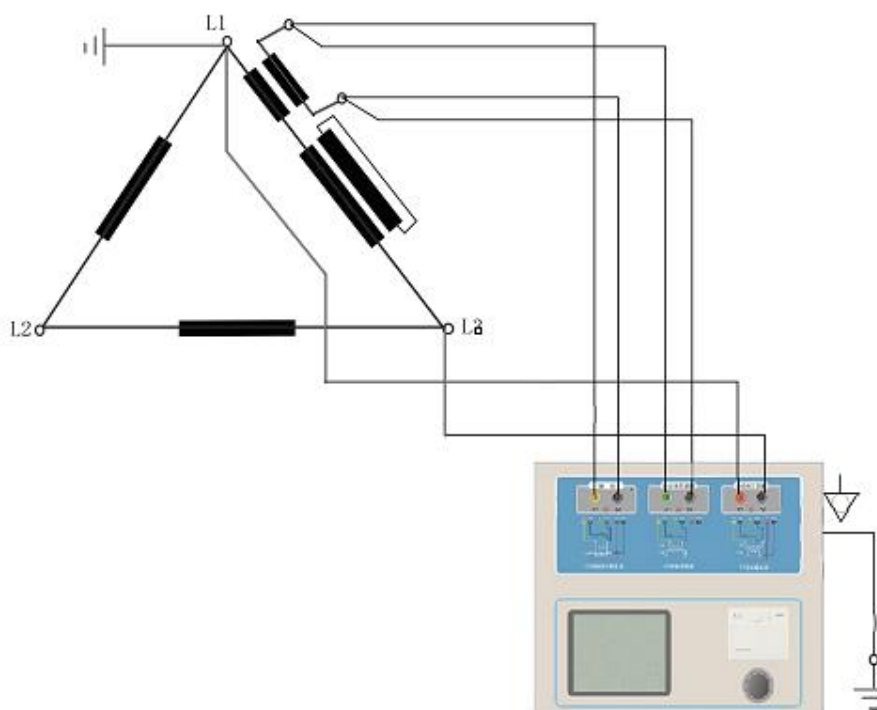

Figure D.2 ZHXQ-B in the triangle on the transformer connection when the connection mode test

2. ZHXQ-B for transformer testing casing CT Connection shown in Figure D.3.

Attention: H1 terminal must be disconnected first. Otherwise, if one took the short side, the ZXHQ-B cannot obtain the correct result.

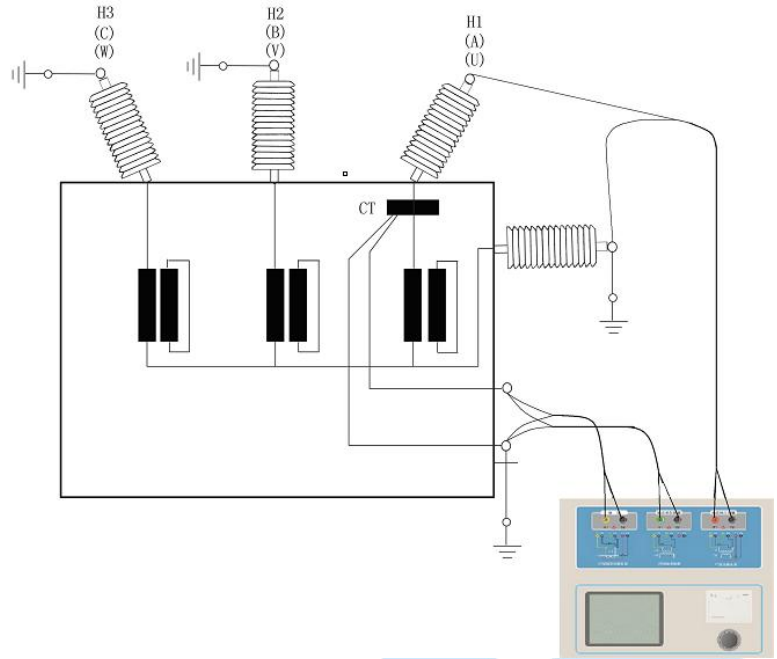

Figure D.3 ZXHQ-B on the transformer bushing testing at the time of CT Connection

4. ZXHQ-B in the GIS (SF6) switch on the wiring of the CT test mode as shown in Figure D.4. NOTE: Disconnect all connected with the bus switch, grounding switch closed.

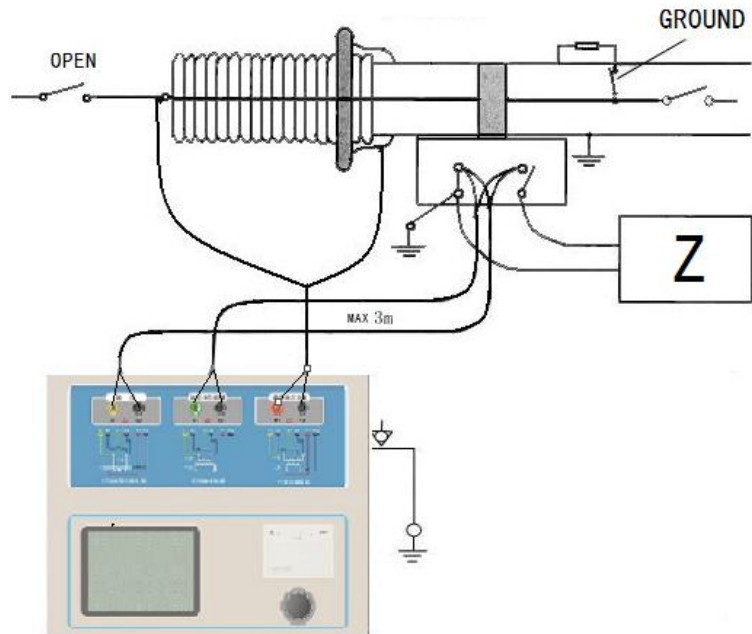

Figure D.4 ZXHQ-B on GIS (SF6) switch on the test at the time of CT Connection

D. Four-Terminal Method Of Measuring Principle Wiring

Impose a voltage output signal V_s to a source impedance R , will produce a current I , in figure E.1

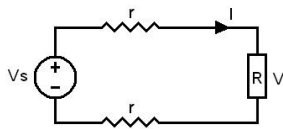

Figure E.1

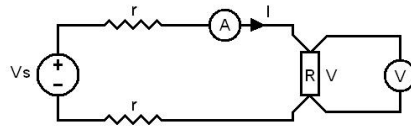

figure E.2

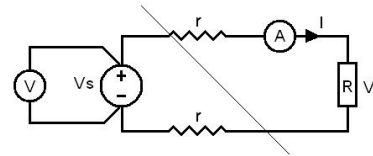

figure E.3

For measurement of the impedance value, the impedance measurement of the voltage U is needed :

$$R = V / I$$

From the measured impedance voltage source to some wires, wires have resistance r , resulting in $V = V_s$, so if the accurate measurement of impedance R , can not simply replace the V_s with V .

Impedance R of the measuring circuit should be used Figure E.2 connection method, measuring the voltage meter voltage must be separate from the R at both ends with wire connection to the accurate measurement of R value of the voltage V . R is used at both ends by four wire cables, it is known as 4-side wiring method. Figure E.3 of the wiring is wrong. Adopt ZXHQ-B measure the resistance, variable ratio, excitation; the law of transformers is required to use 4-side wiring, in figure E.4

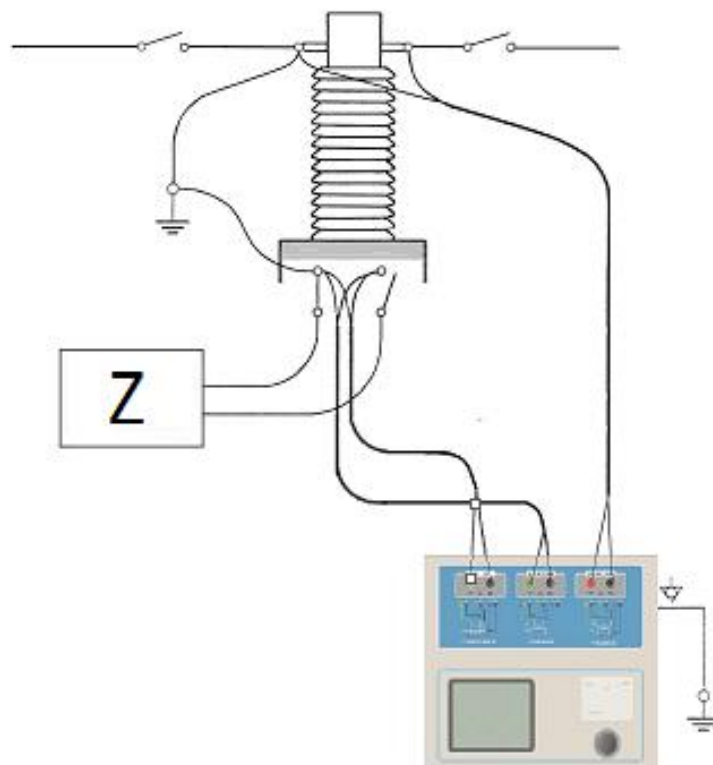

Figure E.4

Four-terminal method under test must pay attention to wiring terminal connection winding.

Figure E.5 the connection is correct, Figure E.6, 7 the connections are wrong.

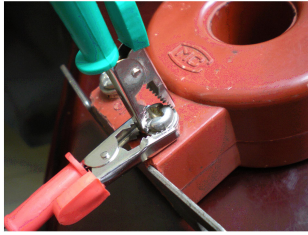
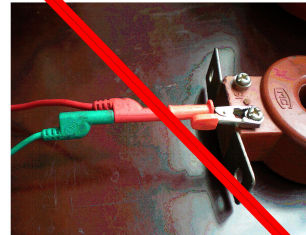

Figure E.5



Figure E.6



FigureE.7

