

ZXHL-100P
Contact Resistance Tester



Contents

I 、 product description.....	- 2 -
II 、 Product Usage.....	- 2 -
III、 Features.....	- 2 -
IV、 Technical Specifications.....	- 3 -
V 、 Panel structure.....	- 3 -
VI、 working principle.....	- 4 -
VII、 Method of operation.....	- 5 -
1. LCD Description.....	- 5 -
2. Turn the mouse Description With.....	- 5 -
3. The correct wiring.....	- 5 -
4. Power.....	- 6 -
5. The main interface.....	- 6 -
6. Test menu interface.....	- 6 -
7. Test Results.....	- 7 -
8. Save the test results.....	- 8 -
9. records check.....	- 9 -
10. Time set.....	- 12 -
11. Communication Interface.....	- 12 -
VIII、 Precautions.....	- 13 -
IX、 Packing List.....	- 13 -
X、 Symptom and exclusion.....	- 14 -
Appendix I: Contact (loop) resistance Basics.....	- 15 -
Appendix II: conductive contact breaker (circuit) resistance standard reference value.....	- 15 -

I、product description

Once the power system commonly used conventional QJ44 type arm DC bridge for measuring the contact resistance, and such bridge only test current at mA level, it is difficult to find transformer coil conductor cross-sectional area reduced defects. When measuring the high voltage switch contact resistance of the conductive circuit, due to the impact of oil film between the contact and the oxide layer, the measured resistance value is too much times larger that can not reflect the real value of the contact resistance.

Is designed by using high-frequency switching power supply technology, combined with digital circuit technology. It is suitable for measuring switching control equipment contact resistance. The test current is national standards DC 100A. In the case of current 100A, contact resistance is directly measured, the final test results show in large-screen LCD, with data storage, printing, time settings and other functions. 50A also selectable. The instrument measurement is with high accuracy, stable performance, able to meet the power industry, high-voltage switchgear maintenance and high voltage switch factory contact resistance test requirements.

II、Product Usage

Is suitable for high-voltage switch contact (loop) resistance measurement, it also applies to occasion when need large current, micro resistance measurements

III、Features

1. Use latest power supply technology, the tester can continuously output high current which overcomes the weakness of instantaneous current produced by pulsed power. It can effectively breakdown/puncture the oxide layer of the switches and then get precise
2. High stability. under strong interference, the last number displayed by the LCD is within the range of $\pm 1d$, with steady reading and good reproducibility
3. High precision: adopts double channels high-speed 16bits Σ - Δ AD to sample, digital signal processing technique, the maximum resolution up to $0.01\mu\Omega$.
4. Intelligent: use high performance CPU, system can switch the measurement range according the size of the signal during testing to ensure the accuracy. The over-temperature protection circuit can auto stop output the current when the device exceeds the rated temperature to ensure the safety.

5. High quality: key parts are imported components, with temperature compensating circuit in perfect design which eliminates the effect of ambient temperature
6. Powerful: several modes of currents for option
7. Friendly man-machine interface: enter the data by rotating mouse, easy and convenient, can set the data, time by yourself, save and print the test results in time.
8. Several communication modes: can connect and upload the data to the PC by RS232 or USB, for further analysis and processing.
9. Easy to use, small volume and little weight

IV、 Technical Specifications

1. Measuring range: 0 ~ 2999.9 $\mu\Omega$
2. Resolution power: 0 ~ 99.99 , 0.01 $\mu\Omega$;
100.0 ~ 2999.9 , 0.1 $\mu\Omega$
3. Test current: DC50A, 100A fourth gears fixed output
4. Measurement accuracy: $\pm (0.2\% rd + 2d)$
5. Continuous working time: 5s ~ 599s
6. Display: large-screen LCD
7. The communication way: RS232 serial port (USB for option)
8. Power supply: AC220V \pm 10% 50Hz
9. Total power: > 600W
10. The maximum storage capacity: 200 records
11. Working environment: Temperature -10 $^{\circ}\text{C}$ ~ 40 $^{\circ}\text{C}$ Humidity \leq 80% RH
12. Volume: 313 \times 270 \times 235 mm
13. Net Weight: 6kg (without accessories)

V、 Panel structure

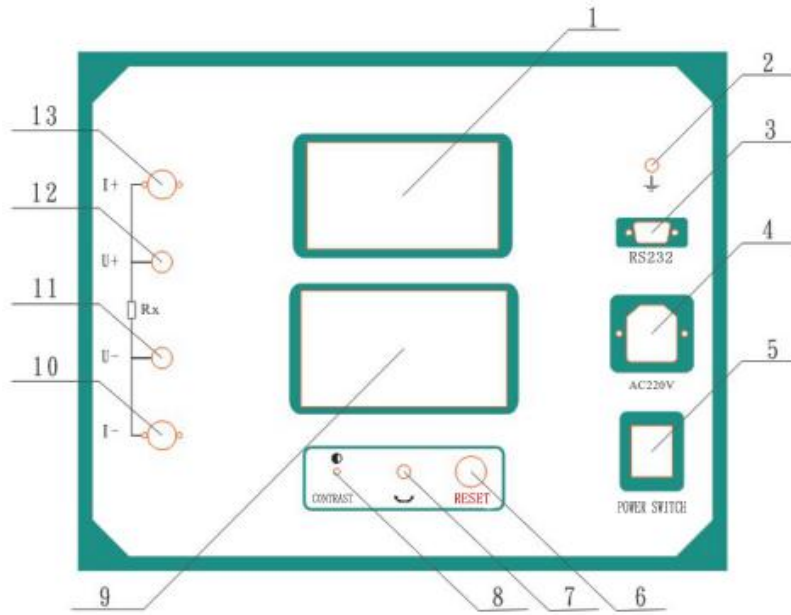

Figure 1 panel layout

1、 printer	2、 Grounding	3、 RS232 Interface
4、 Power socket	5、 Power switch	6、 Reset
7、 Rotating mouse	8、 Contrast control	9、 LCD screen
10、 Current output I-	11、 Current output V-	12、 Measuring input V +
13、 Measuring input I-		

VI、 working principle

The instrument uses the current-voltage testing theory, also known as four-wire method testing technology, schematic block diagram shown in Figure 2.

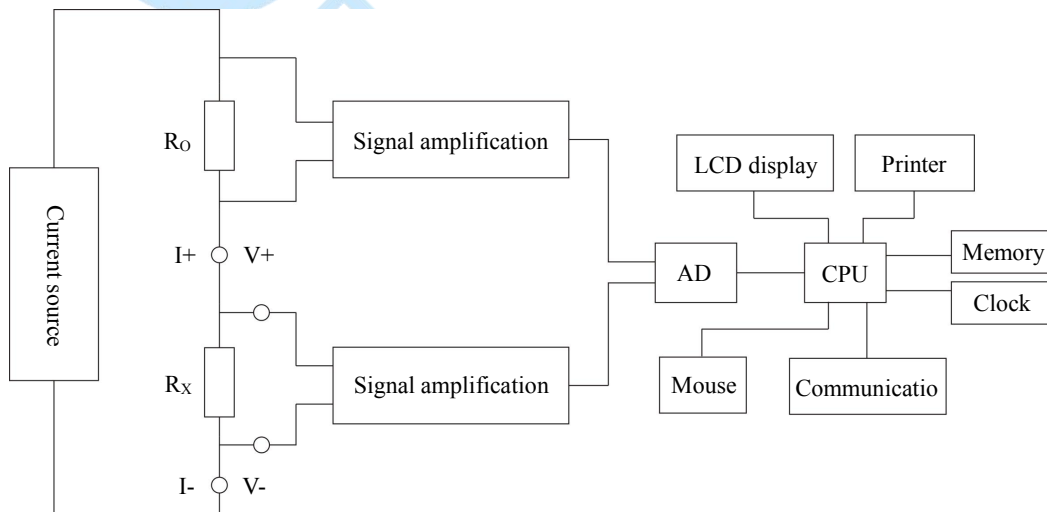

Figure 2 Test Schematic

Power source output constant current which flows through standard resistor R_0 and R_x to be

measured. Voltage signal U_0 is sampled on the standard resistor R_0 , after filter amplification processing, is sent to the AD convertor and changed to digital value, then get the current value I , see equation (1). Similarly, the sampled voltage signal U_x measured on resistance R_x after filtering, multiple-stage amplification process, AD conversion, changes into digital value, by the formula (2) can calculate the resistance value R_x .

$$I = \frac{U_0}{R_0} \quad (1)$$

$$R_x = \frac{U_x}{I} \quad (2)$$

VII、 Method of operation

1. LCD display explanation

This instrument uses a high-resolution 240×128 gray backlit LCD, it can clearly show even in strong sunlight. Parameter setting and test results are displayed on the LCD screen. English interface with graphics clear, beautiful. It is easy to operate.

2. Rotating mouse

Rotate the mouse has functions like a mouse used on computers, it has three modes of operation: "Left", "Right", "click to select." These three operations by the mouse can realize cursor moving, the selected data entry and operations functions.

Move the cursor: by rotating the mouse left or right to move the cursor, move the cursor to the option you want to select, "click" knob to select

Data Entry: When you need to modify or enter data, move the cursor to the option, click the mouse, move left or right for increase or decrease operation, click the mouse to confirm. Then rotate the mouse into the next one. Bit by bit after completion, move the cursor by rotating the mouse

3. The correct wiring

Connect the wires according to the correct wiring method shown in Figure 3.

(a) Four Terminal Wiring Diagram

(b) Wrong Connection

Figure 3 four-terminal wiring diagram

Note: ① Tighten the connection between the instrument panel and test line. It should not be loosening.

② wiring should be in accordance with the four-terminal method, the current line should be on the outside, the voltage line to be caught in the inner side, current and voltage must be of the same polarity.

4. Power

After confirmation that test line wiring is correct, access to 220V AC power, open the power switch, the instrument into the boot state. When turned on, the buzzer ring for a short time indicating the system is powered on.

5. The main interface

Turn the power switch, the system enters the main interface, shown in Figure 4.

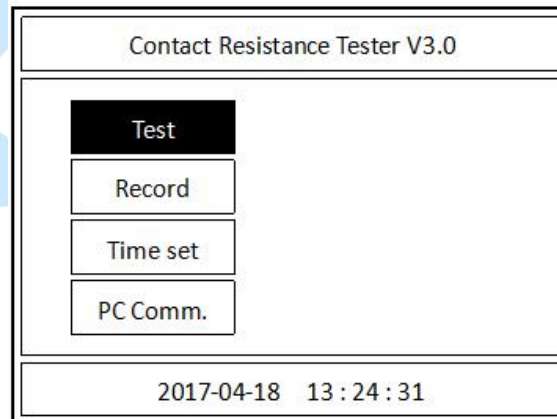

Figure 4 Main interface

Move the cursor to "start test", "records check," "Time Settings", "Online Communication" for switching. Bottom of the main screen displays the current time.

6. Test menu interface

Select "Start Test" item, click on the mouse, the instrument into the test menu interface, shown in Figure 5 in the main interface. Default test current is 100A, test time is 10s.

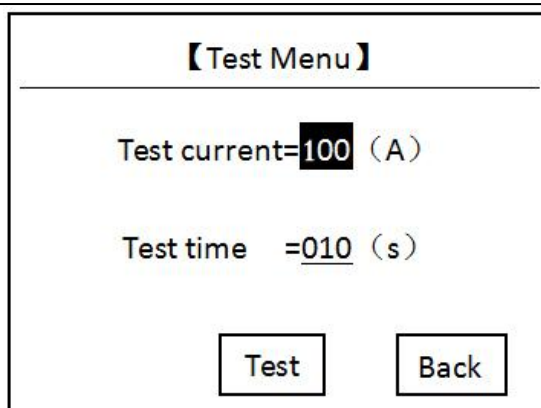

Figure 5 Test menu interface

In the "test current" position click mouse to switch the current value between 50A, 100A; rotate the mouse to the "test time" position, using a rotary mouse input data, you can set the test time. Note: The test time setting range: 5s ~ 599s, when beyond the scope, the system returns to the default value: 10s. In order to ensure more accurate test results, recommended test time using default values 10s.

Click on the "Test" key, the system enters the "Test Results" screen.

Click on the "return" key, the system returns to the previous screen.

7. Test Results

Click on the "Test Menu", then "test" to enter into the "Test Results" screen, as shown in Figure 6. Sequentially displayed is resistance value, test current value and test time on screen. Note: At this point the current line, there are large current flows, the current line must not be forcibly pulled out, otherwise it may cause harm to the operator and the instrument.

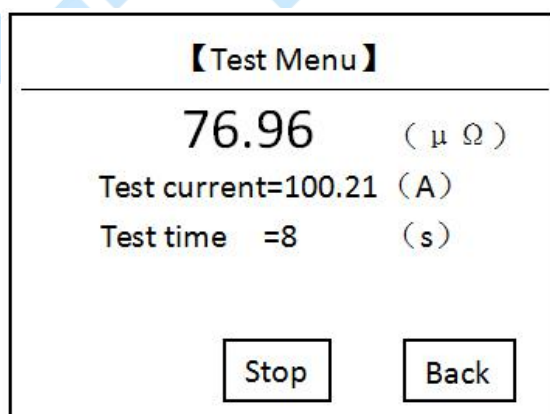
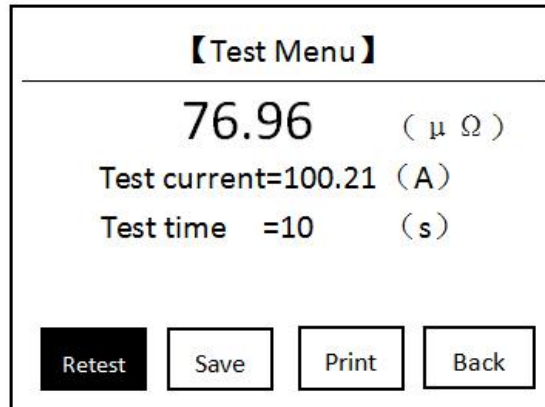

Figure 6 Test Results - Test

When testing, the system displays the "stop", "Return" key. Click on "Stop", the system stops counting, the current stops output. Click on "Back", the system stops counting, the current stops output and return to the previous screen. Note: The first few seconds of the beginning of the test,

due to the current impact and capacitor charging, the test results unstable, 5s later the test results will be stabilized, the user can record data.

When time is up, current output will stop automatically



Click on the "retest" item, the system repeat the test according to preset parameters

Click "Save" item, the system enters the "Save Test Results" screen.

Click on "Print" item, the system will print all the information, including sample number, test time, test current, resistance value, the test date.

Click on the "return" key, the system returns to the previous screen.

If the measured value exceeds the measuring range, the LCD screen displays "out of range" and shown in Figure 8, also the buzzer will alarm. At this time the current continue to output until the end of counting.

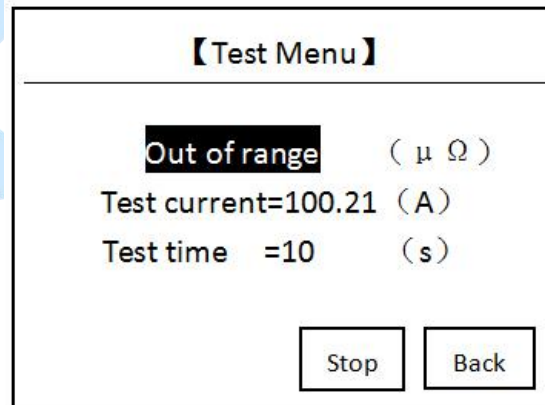

Figure 8 Test Results - outside the measuring range

8. Save the test results

In the "Test Results" screen, click "Save" button, the system enters the "Save Test Results" screen, shown in Figure 9.

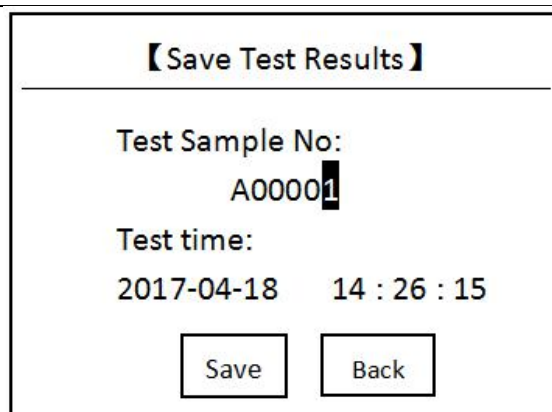

Figure 9 Save Test Results

Use the mouse to enter the sample number, click "Save" item, the test results will be saved to the I²C memory, interface shown in Figure 10 ; click on "Back" key, the system returns to the previous screen.

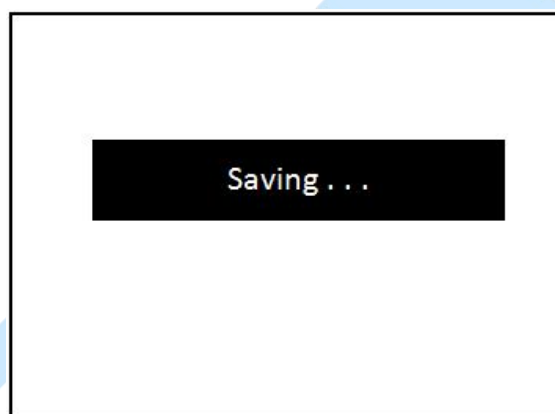

Figure 10 Preservation

The instrument can store up to 200 records, if memory records more than 200, the system prompts "memory is full, please delete", shown in Figure 11. To complete the single or delete all records in the record query interface.

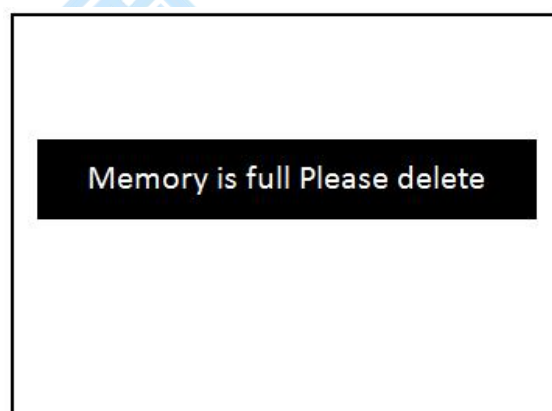

Figure 11 Memory full Delete

9. records check

In the "main screen" click "record", the system enters the "Record inquiry" interface, shown in

Figure 12.

【Record Inquiry】			
No.	Date	ID	
001	04 - 12 09:15	A00010	<input type="button" value="↑ ↓"/> <input type="button" value="Query"/> <input type="button" value="Delete"/> <input type="button" value="Clear"/> <input type="button" value="Back"/>
002			
003			
004			

Figure 12 Records check

Click the "↑ ↓", rotating the mouse, select the record number to be queried, as shown in Figure 13.

【Record Inquiry】			
No.	Date	ID	
001	04 - 12 09:15	A00010	<input type="button" value="↑ ↓"/> <input type="button" value="Query"/> <input type="button" value="Delete"/> <input type="button" value="Clear"/> <input type="button" value="Back"/>
002			
003			
004			

Figure 13 Records check

on the selected record, click the mouse to enter operation interface, shown in Figure 14.

【Record Inquiry】			
No.	Date	ID	
001	04 - 12 09:15	A00010	<input type="button" value="↑ ↓"/> <input type="button" value="Query"/> <input type="button" value="Delete"/> <input type="button" value="Clear"/> <input type="button" value="Back"/>
002			
003			
004			

Figure 14 Records check

There are functions like “delete” for deleting this record, “clear” for call records cleared, “back” to return. Click on “Query” then the system displays detailed information on this record, as shown in Figure 15.

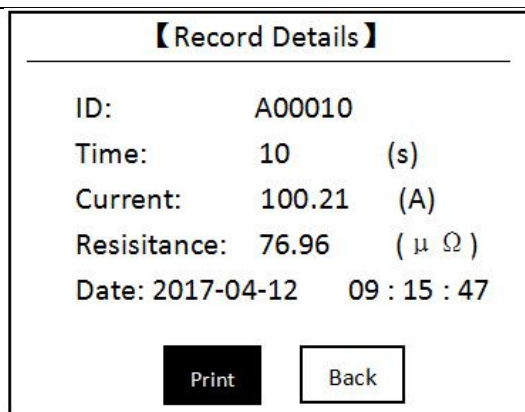

Figure 15 Search record

Click the "Print" button to print this record, print the results shown in Figure 16. Click "Back" to return to the previous screen.

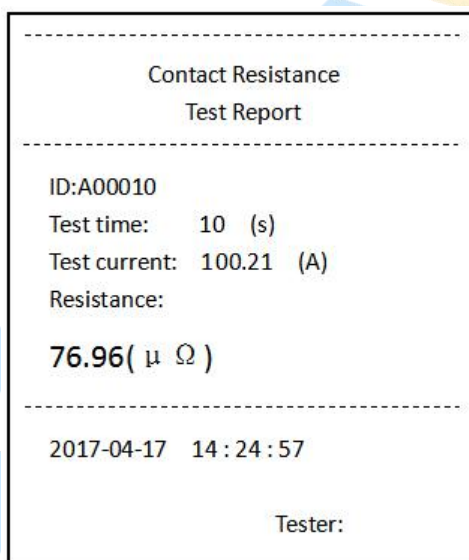

Figure 16 Print Report

Click the "Delete", the system prompts "Delete?", Shown in Figure 17. Click "OK" to delete this record; click "Cancel" to return to the previous screen.

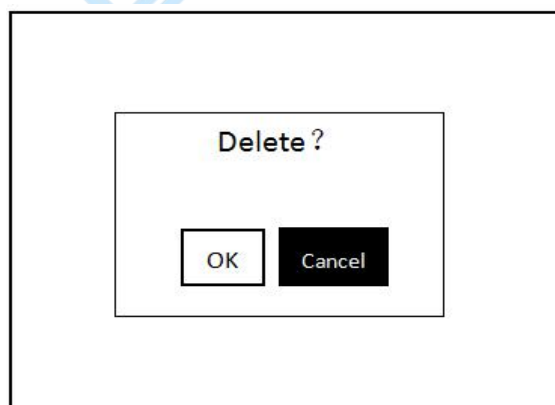

Figure 17 Delete

Click "Clear", the system prompts "Clear?", Shown in Figure 18. Click "OK" to clear all the

records; click "Cancel" to return to the previous screen.

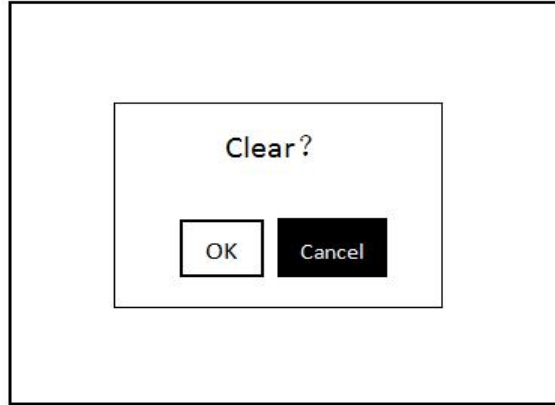

Figure 18 Are Empty

Click on "Back", the system returns to the main screen.

10. Time set

Click on "Time Set" and enter "time" interface, shown in Figure 19. In the main interface.

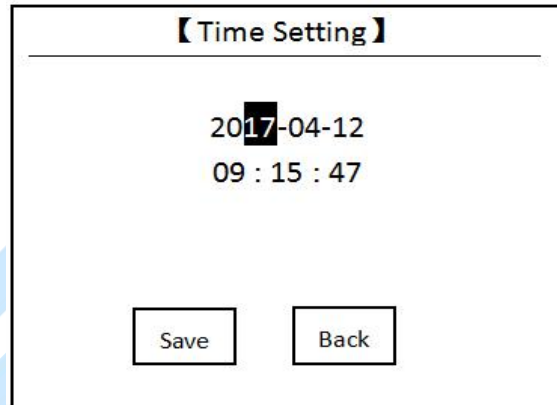

Figure 19 time setting

Move the cursor to the position of the date and time that need modify, use the mouse to enter the correct date and time values, click "Save", the system will save the newly set date, time and return to the main menu; click on "Back", the system return to Main interface.

11. Communication Interface

In the main screen, click "Online Communication", the system enters the communication interface, shown in Figure 20. Note: Please install the appropriate drivers before communicating, software driver installation procedure please refer to software operating section, please make sure that the instrument connected to the computer via RS232 serial cable or USB cable.



Figure 20 Online Communication

12. After the measurement is completed, disconnect the power switch, put back accessories to the package.

VIII、Precautions

1. Please read the instructions carefully before using the instrument.
2. Please connect the wiring in accordance with the instructions.
3. The test instrument should not be used to test live circuit contact resistance.
4. The instrument must be fitted with a reliable grounding
5. The current line should not be easily replaced
6. The instrument should be placed in ventilated, dry, cool, clean place when not use, and it should be prevented from moisture, anti-corrosive gases.

IX、Packing List

- | | |
|----------------------------------|----------|
| 1. The main machine | 1 pcs |
| 2. Test line | 1 set |
| 3. Ground wire | 1 thread |
| 4. AC220V power line | 1 thread |
| 5. 10A fuse | 3 pcs |
| 6. Product Manual | 1 copy |
| 7. Printing Paper | 2 roll |
| 8. Inspection Report | 1 copy |
| 9. Certification / warranty card | 1 copy |

X、Symptom and exclusion

Symptom	Troubleshooting
Nothing happens when turned on, the LCD screen no display	Check whether connect with the AC power supply
	Check the power cable
	Check if the fuse has been burned inside the base
When testing the resistance value is significantly large or over the range	Check whether the measured resistance value is too high
	Check the voltage input cable is connected to the inner side of the current output lines
	Check if the test leads polarity is reversed
	Check voltage output lines are connected well or not, whether the DUT connector is oxidized
Rotating the mouse unresponsive	Turn the power and restart
	Press the reset button to reset the instrument
Communications unsuccessful	Check the data cable is connected
	Check whether the instrument is brought online
	Re-install the driver after uninstalling
	Press the reset button to reset the instrument

Appendix I: Contact (loop) resistance Basics

1. What is the contact resistance?

Contact resistance is additional resistance static contact with each other when in contact with the movable contact that appears.

2. The circuit breaker contact resistance which several parts?

Shrink resistance static contact resistance of the contact portion and the surface is composed of two parts move.

3. The circuit breaker contact resistance reasons for failure?

- a. contact burn when breaking a large short-circuit current.
- b. due to poor institutional adjustment fixed is not strong, resulting in changes in itinerary, when overstroke serious failure, caused by the contact pressure or the contact area changes.
- c. After the breaker installation commissioning and long-term is not in operation, so dynamic and static contact surface oxidation, the contact surface resistance increases.
- d. long-running spring deformation, so that the contact pressure drops.
- e. after long-term operation of the mechanical parts caused by mechanical wear.
- f. for less oil circuit breakers, also may be due to defective insulation value oleic acidic reaction, etching the contact surface. Or oil floating impurities, move, carbonaceous particles between the stationary contact after breaking the short-circuit current due to the residual metal powder, the contact resistance increases.

4. The factors affecting the contact resistance?

- a. material properties: hardness, chemical properties, mechanical strength and resistivity of the metal compound.
- b. contact form: point contact, line contact, surface contact.
- c. contact surface condition: When (silver exceptions) the contact surface to form an oxide film, the oxide film resistance than the metal itself is much greater.
- d. contact pressure.
- e. the roughness of the contact surface.

Appendix II: Circuit breaker conductive contact resistance standard reference value

model	Each phase contact resistance ($\mu\Omega$)	model	Each phase contact resistance ($\mu\Omega$)
SN1-10	<95	DW1-60G	200
SN2-10G	75	SW1-110	700
SN4-10	50—60	SW2-110I	180
SN4-20	50—60	SW3-110	160
SN4-10G	20	SW4-110	300
SN4-20G	20	SW6-110	180—220
SN5-10	100	SW2-220	400
SN6-10	80	SW4-220	600
SN10-35	<75	SW6-220	<400
DW1-35	550	SW7-220	<190
DW1-60	500	KW1-220	400
DW3-110	1100—1300	KW2-220	170
DW2-110	800	KW3-220	110
KW1-110	150	KW4-220	130
KW3-110	45	DW2-220	1520
KV4-110A	60	DW3-220	1200
DW3-110G	1600-1800	SW6-330	>600