

**ZXKC- IV Circuit Breaker
Dynamic Characteristics Analyzer**



Contents

I Product overview.....	- 2 -
II Performance characteristics.....	- 2 -
III Technical indicators.....	- 3 -
IV Panel diagram.....	- 5 -
V Installation Method of Fracture Lines and Sensors.....	- 6 -
VI Menu description of the apparatus.....	- 13 -
VII Method of operation.....	- 22 -
VIII Term definition.....	- 24 -
IX Troubleshooting method of the device.....	- 25 -
X Daily maintenance.....	- 26 -
XI Energy storage instructions.....	- 27 -
XII Packing list.....	- 27 -

I Product overview

This instrument can be used to test and measure the mechanical characteristic parameters of various voltage levels of vacuum, sulfur hexafluoride, less oil, more oil and other high-voltage switches in power systems. The measurement data is stable and strong in anti-interference. It can be tested in power stations of 500kV and below. The wiring is convenient and the operation is simple. It is the most convenient tool for high-voltage switch maintenance test.

II Performance characteristics

1. The instrument can automatically identify the breaking and closing state to prevent misoperation.
2. Independent fracture 6 can test and indicate connection status of fracture so that it is convenient for users to check wiring.
3. The device can store hundred sets of testing results.
4. Its big screen (320×240) LCD display is an advanced grey screen which does not reflect or black screen in sunshine. Besides, its menu interface with clues of pictures and characters menu operation is rather personal and easy to operate.
5. The device has powerful graphical analysis function, which makes it possible to display waveform and measured data simultaneously. Thus testing process is more self-evident.
6. The device contains delay and protection function, which makes it possible

to cutoff coil voltage automatically after circuit breaker operates. Therefore, the circuit breaker and the testing instrument are well protected. Independent and special switching control unit, i.e. switching or closing control unit, can be used for either switching or switching test. If one of the control circuits is broken, it will not affect the use.

7. The device can be used to carry out electric and manual switch test.
8. The device can be used in experiment of low voltage and high voltage, and seek the minimum voltage or closing voltage automatically.
9. It can be used in reclosing experiment for parameters measurement of closing-opening, opening-closing and opening-closing-opening.
10. Parameter measurement of vacuum contactor (single coil) .
11. Fully automatic completion of circuit breaker aging test (life test).

III Technical indicators

1. Time measurement: fracture 6

Inherent opening (closing) time

Different period of opening (closing)

Different period between opening (closing)

Bouncing time of closing (opening) (bouncing times)

Measurement range: 0.01ms~15000ms

Accuracy : 0.5%±2 characters

2. Speed measurement: opening(closing) speed

The average speed for designed period of time (distance or angle range)

Speed measurement range: 1mm sensor 0.01~25.00m/s,

0.1mm sensor 0.001~2.50m/s

Universal sensor: 0.01~25.00m/s

3. Distance measurement: moving contact travel (travel)

Contact travel (contact separation)

excess of stroke

4. Sensor measurement range

1) linear displacement sensor 50mm, resolution: 0.1mm, distance 0.1 ~ 50mm

2) linear displacement sensor 300mm, resolution: 0.1mm, distance 10~ 300mm(optional)

3) linear displacement sensor 500mm, resolution: 1mm, distance 10~ 500mm(optional)

4) 360 line sensor: 360°, resolution: 0.25°, distance 1mm~1000mm

5. Current measurement range: 0 ~ 15A, resolution: 0.01A, indicating the current value is the maximum coil current.

6. Display screen: 320×240 Liquid Crystal Display, contrast adjustable

7. Data storage: a hundred sets of measuring data

8. Printer: High speed thermal printer

9. Apparatus power supply: AC 220V ± 10%; 50Hz ± 2%

10. DC power supply: output voltage: 22 ~ 245V continuously adjustable, output current: ≤ 15A(short time)

11. External trigger voltage: AC220V, current ≤120A

12. Energy Storage Motor Power Supply: Output Voltage: 22-245V

Continuously Adjustable, Output Current: <15A (Short Time)

13. Host volume: 360×250×140mm

14. Operational environment: $-10^{\circ}\text{C}\sim+50^{\circ}\text{C}$

15. Relative humidity: $\leq 90\%$

IV Panel diagram

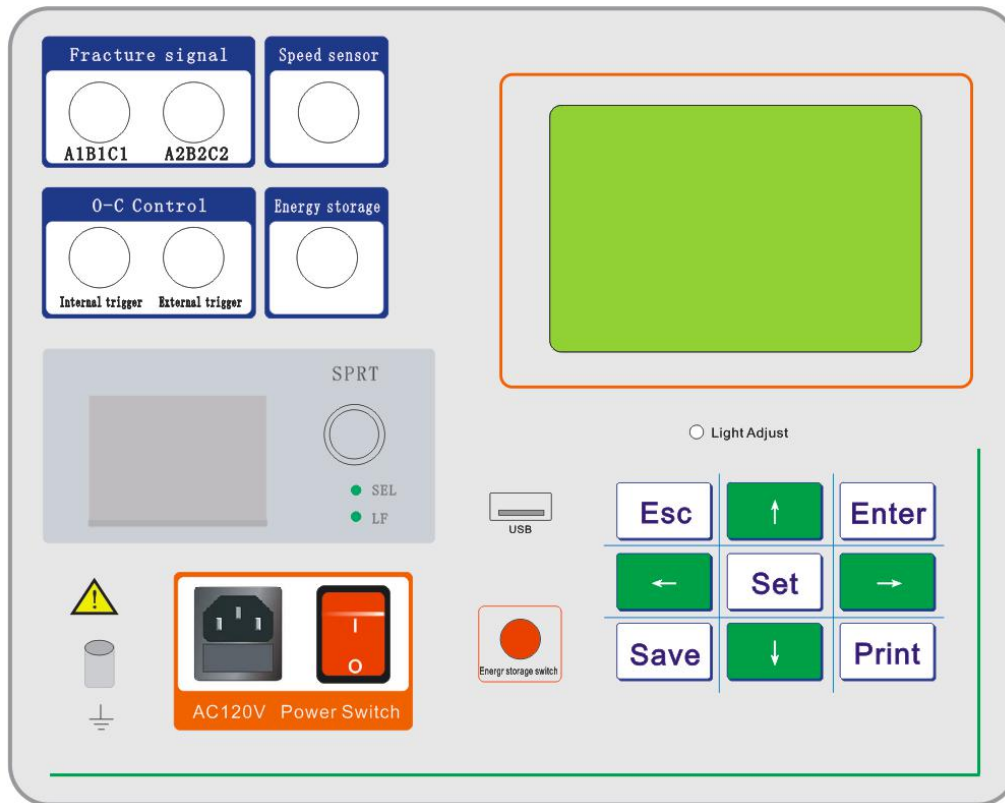

Fracture Signal: contact to different dynamic and static contact of fracture

Speed sensor: used to connect the speed sensor.

Internal trigger: on, off, - are controllable DC power supply output; green line (on) connects the opening auxiliary contact; red line (off) connects the closing auxiliary contact; black line (-) connects the public end of opening and closing control loop.

External trigger: when external synchronization of AC and DC occurs, there is no need to disconnect secondary circuit control power supply to collect signals. The wiring method is the same as inner trigger method or red line connects the closing coil, green line connects the opening coil, and black line connects the public end. **While wiring, pay attention to switch the power off! And**

pay attention to your safety.



·Please use the 250V, 10A power cord of our company.

·AC power should be suitable to the requirement of $80-150V \pm 10\%$,



60Hz

·10A fuse placed in the fuse box from socket (Spares of fuse is placed

in the box too)

Printer: Filing the needed data for printing. Standard 58mm width thermal printer. You need to open the printer cover to change paper.

Contrast: adjust the brightness of LCD

Button

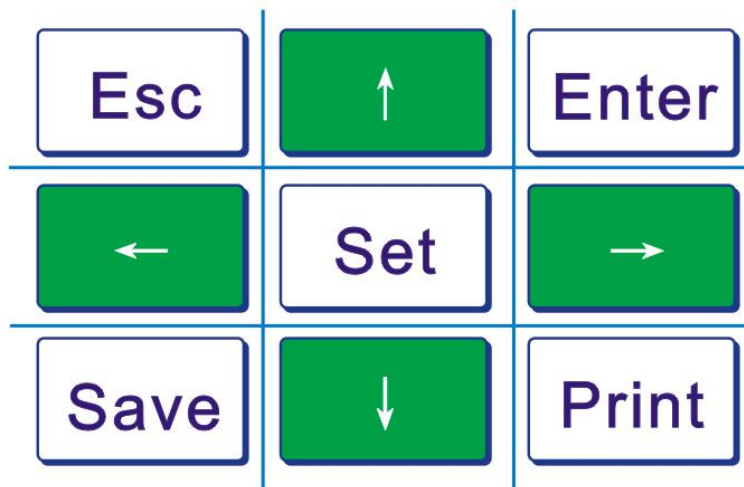

V Installation Method of Fracture Lines and Sensors

1. Installation Method of Fracture Lines

The device has two input interfaces of fracture testing; each fracture has four lines: A1 (yellow line), B1 (green line), C1 (red line) connect tri-phase dynamic contact end, and GND (black line) static contact (tri-phase short circuit). We can take samples from test of breaker of six fractures.

Taking connection of fracture 3 and fracture 6 breaker for example, all fracture testing input interface should be used, and the connection method is as follows: A1 and A2 connect the yellow line of fracture input; B1 and B2 connect the green line of fracture input; and C1 and C2 connect the red line of fracture input. As for three phase three-breaker's connection, we only need to use a last fracture testing signal as input interface. A1 is the main fracture. (Note: fracture 3 breaker and fracture 6 breaker have a common place GND)

Fracture wiring diagram (three fractures)

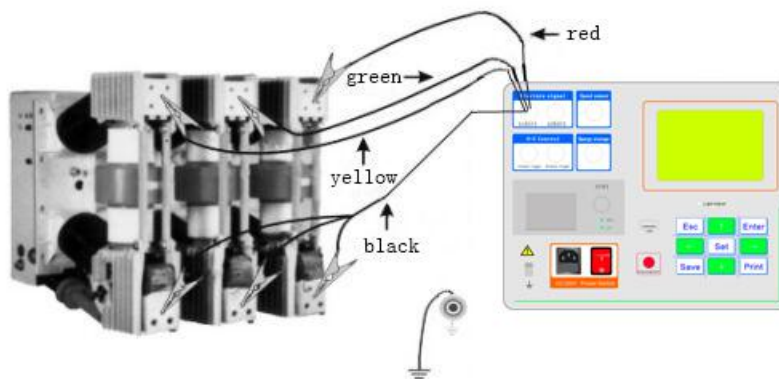

Fracture wiring diagram (six fractures)

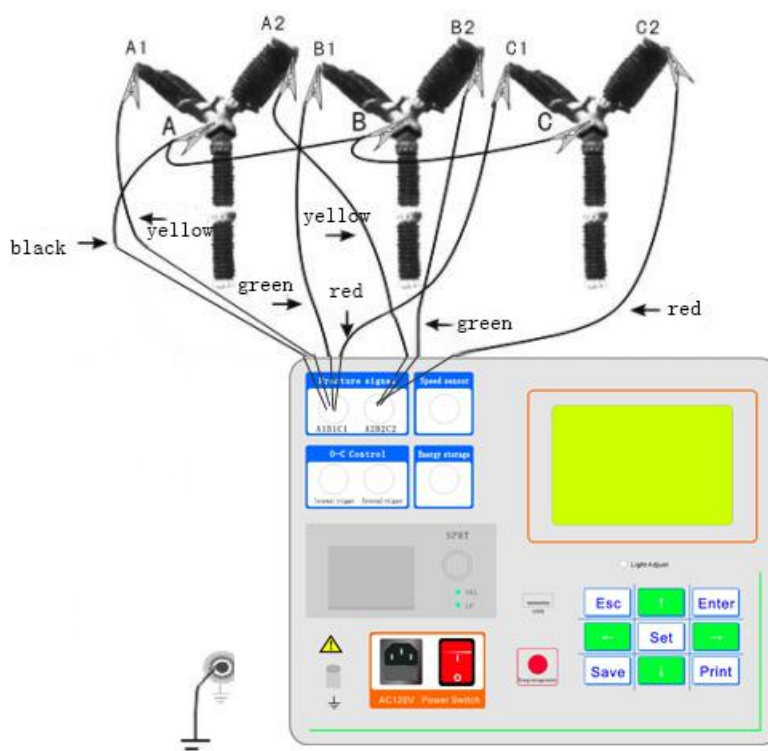

2. Wiring method of internal trigger opening and closing control

During real testing, if inner power of the device is used, closing control line (red), opening control line (green), and public line (black) are connected to “internal trigger” end of the apparatus panel (Air plug), when it comes the opening+, closing +, and negative output of the instrument, we should generally connect them to in front of auxiliary switch contacts to efficiently protect coil and the instrument. **While wiring, pay attention to power off the operating power supply of high voltage switch apparatus (break the cutter or pull the fuse) to avoid power conflict and apparatus damage.**

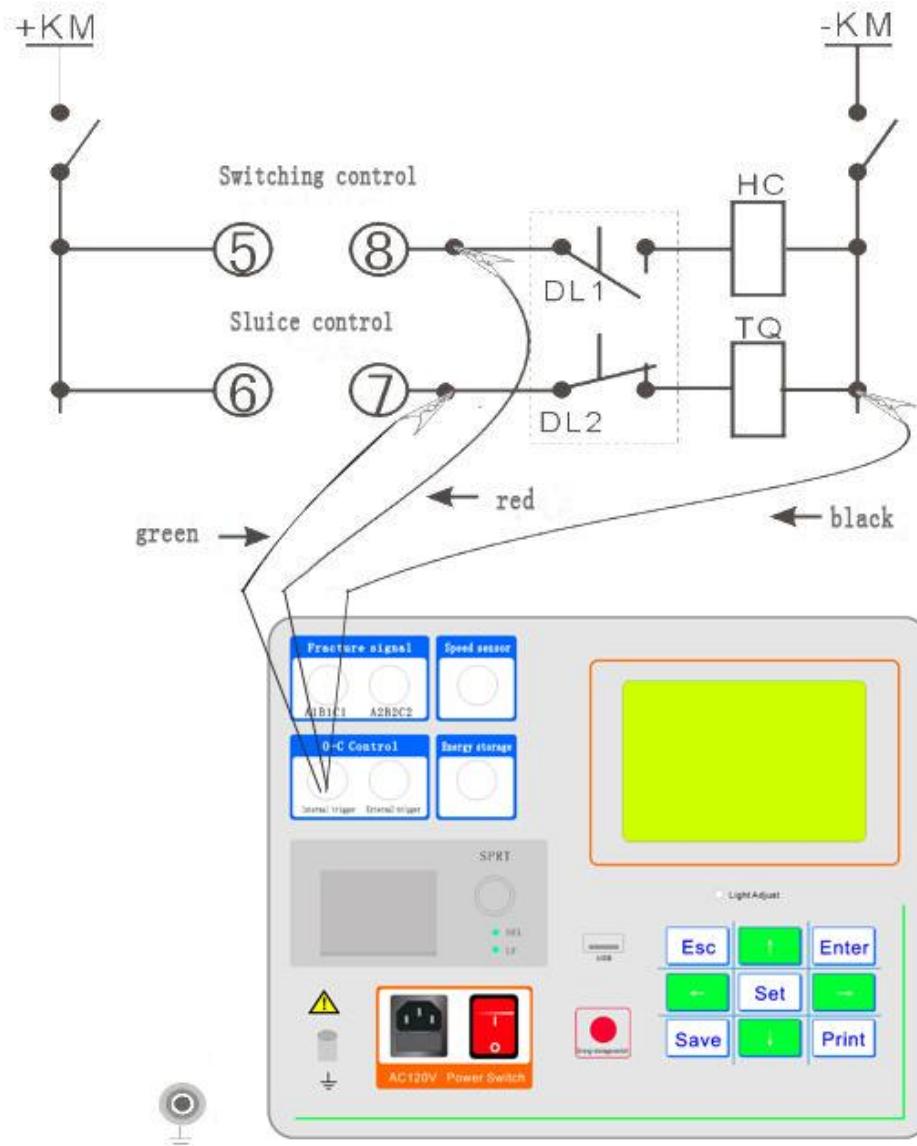

Below is the wiring diagram of opening and closing control for VS1 vacuum switch: closing red line connecting (4), opening green line connecting (31), public point (14) and after (30) short circuit, connect it to black line.

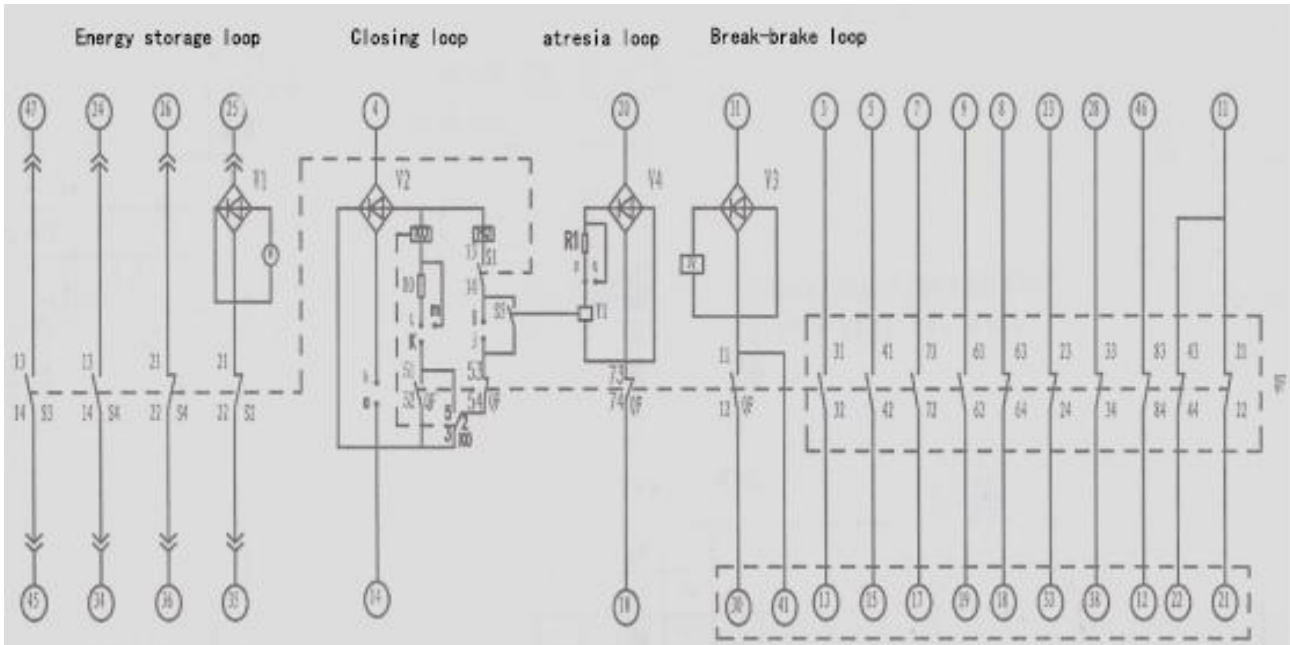

3. Wiring of external trigger (can be used for AC switch without energy storage body or permanent magnet switch)

Before using external power supply, firstly connect controlling line to “external trigger” port of instrument panel, and then start to **set parameters** and set the trigger mode to external trigger. During measurement, firstly press **enter button** on characteristics testing menu to test and wait for signal, and then conduct the opening or closing breaker and then you can collect data. Before wiring, the user should analyze the wiring diagram of all kinds of high voltage switch control screen and then start the wiring.

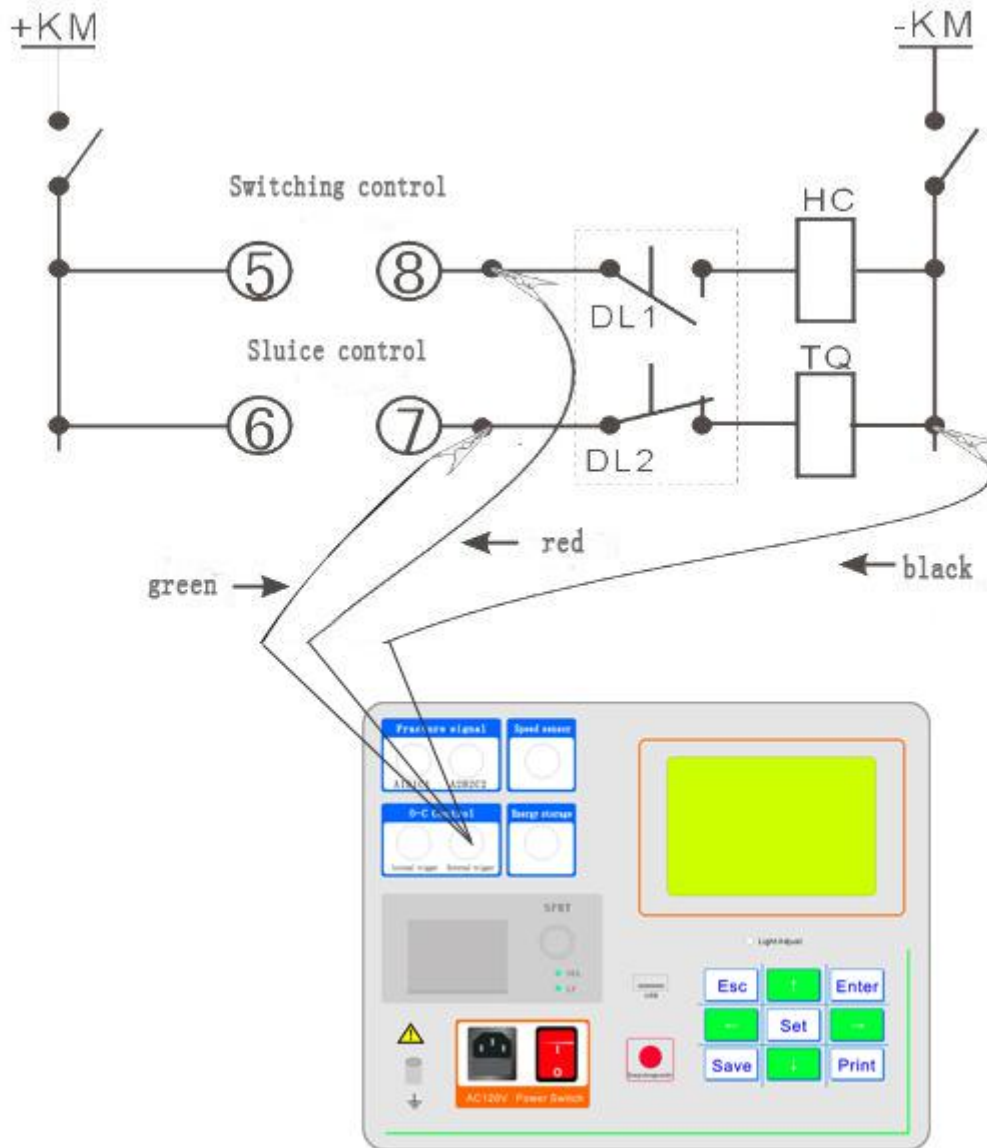

4. **There is no need to connect controlling line in manual mode.** Firstly delay testing time to 3 second in time setting menu. Then start to measure in characteristics testing menu. Then manually start opening and closing quickly. Thus you can collect signal in 3 seconds. If it excesses 3 seconds, you cannot see the data anymore.

5. **Installation method of speed sensors**

While measuring speed of switch, firstly install sensor to dynamic contact of high-voltage switch. Choose corresponding sensors according to type of switch (oil, vacuum, SF6)

0.1 mm linear sensor (vacuum switch type)

Linear pull rod of the sensor is tied to vertical conduct electrical pole of the switch (dynamic contact). Sensor is fixed with a gimbal and will be installed when it is on opening status. During installation, electronic ruler must be vertical to dynamic contact. Firstly pull out about 15mm to ensure that sensor not be pulled broken as the switch moves up-and-down during closing and opening. This kind of installation method is mainly applied to ZN28 switch or vacuum switch with dynamic contact bared of ZN63 (VSI) without chassis.



50mm linear sensor

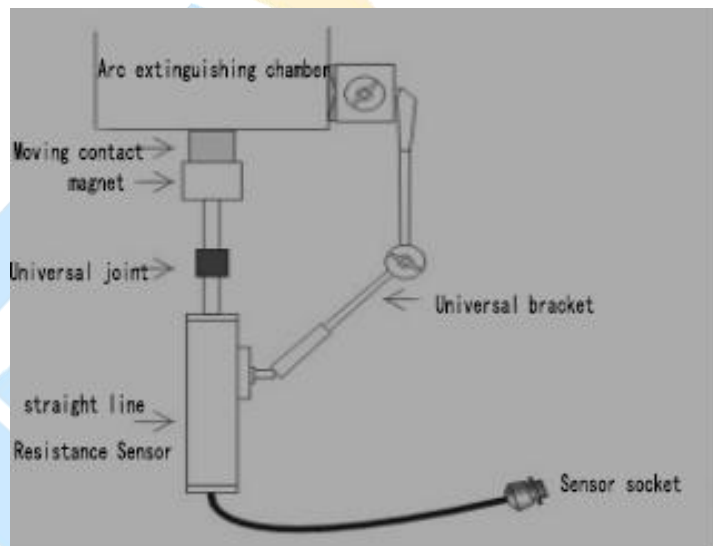

installation diagram

Installation method of 360-line rotating sensor:

- 1) As for sealed switch VS1, VD4, install the connecting lever (principal axis) on switch sides. Take away the white sealing cover on switch sides and quincunx principal axis will appear. Then put on the specific linkers. Please keep horizontally during installation. Then fix it with gimbal. Shown as follows:

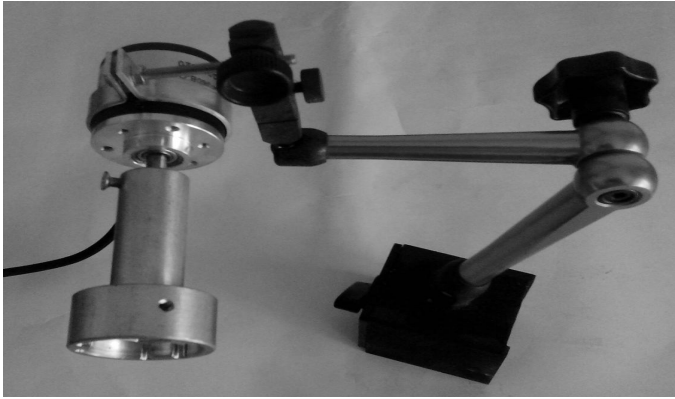

2) If principal axis is in plum blossom form, we use the following method to install, shown as follows::

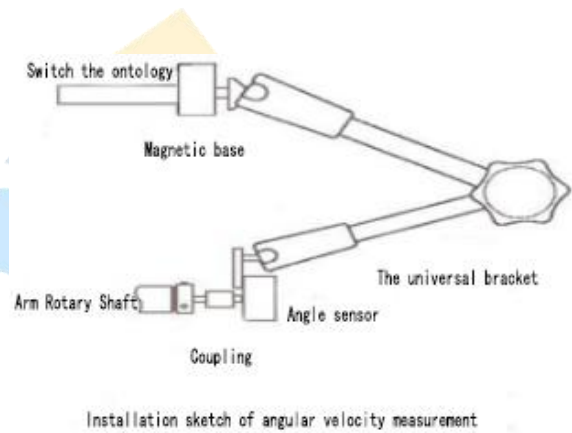

3) Diagram of outdoor vacuum switch and sulfur hexafluoride installation method. This type of installation method is mainly used for our door vacuum switch. Install it to switching pointing needle. You should remove the pointing needle first, and then screw the sensor connector.



Installation of 35KV SF6 Switching Sensor

4) If there are location holes on connecting lever axis of the switch, use connecting-piece and angle-interlocked displacement sensor on actuator

spindle, then use cardan joint to fix angle shift sensor.



Installation of 110KV SF6 Switching Sensor

Diagram for installation of 1mm linear sensor (oil switch)

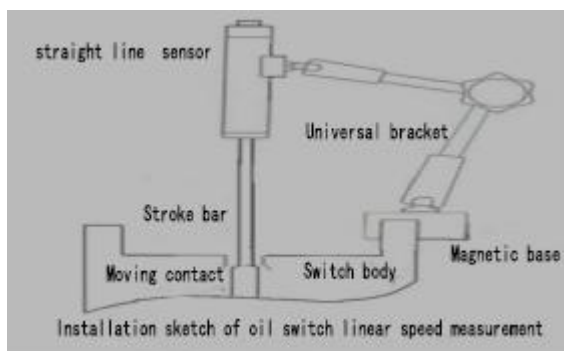

VI Menu description of the apparatus

After wiring and installation, turn on the power supply of the apparatus. At this time, the main menu on LCD is shown as follow:

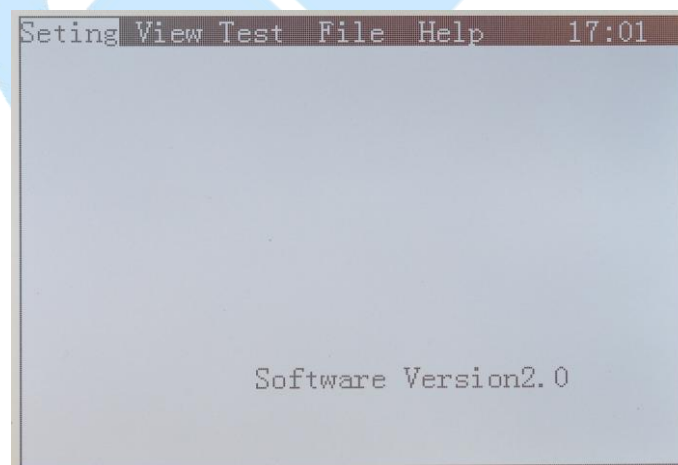

If you only need to test time parameters (such as opening and closing time, bouncing time, bouncing times, synchronization and etc.) of the breaker, you can directly start measuring without setting. Only when you need to

measure speed parameters, you need to set parameters.

1. **Description of setting menu** : press “←”or “→”to **setting menu**, and Press **enter button** to enter, shown as follows:

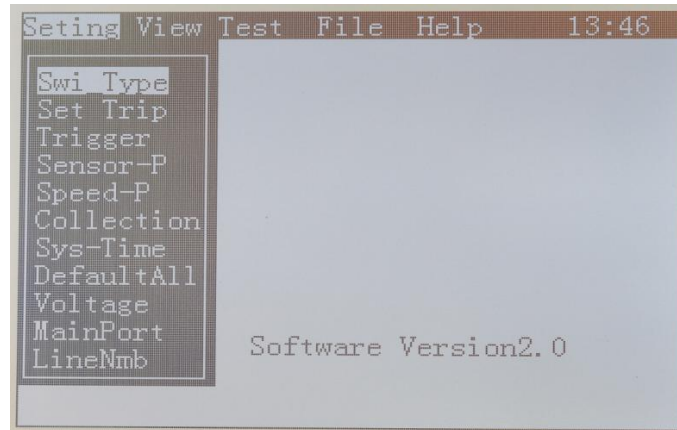

- 1) **Switch type setting**: press **enter button** to enter. Press “↑”or “↓”to move icon. Then press **enter button** to confirm, shown as follows:

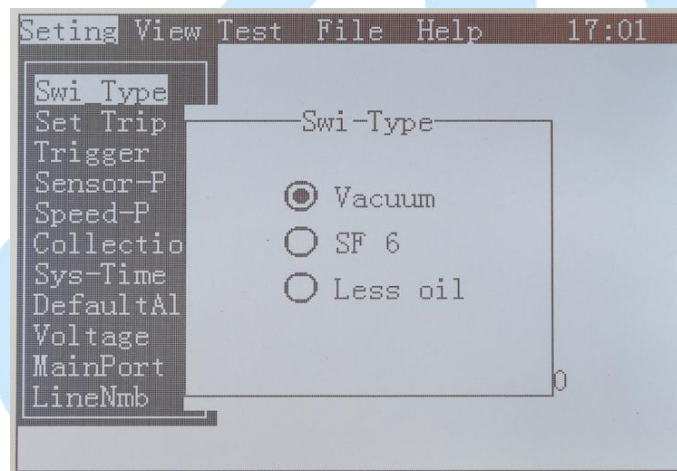

- 2) **Pre-setting travel setting**: travel refers to the total travel of the switch, which means the overall length of opening travel and excess of stroke. Press **enter button** to set parameters, for example, we must set travel for 360-line sensor. “↑”and“↓”are used to adjust numerical value(fine adjustment) and “←”or “→”are used to adjust roughly. When it is adjusted to the needed value, press enter button to save the value. If you choose

the **50mm sensor**, you can set the travel or press **setting button** again, then **default stroke** will appear, then you can start to measure. Shown as follows:

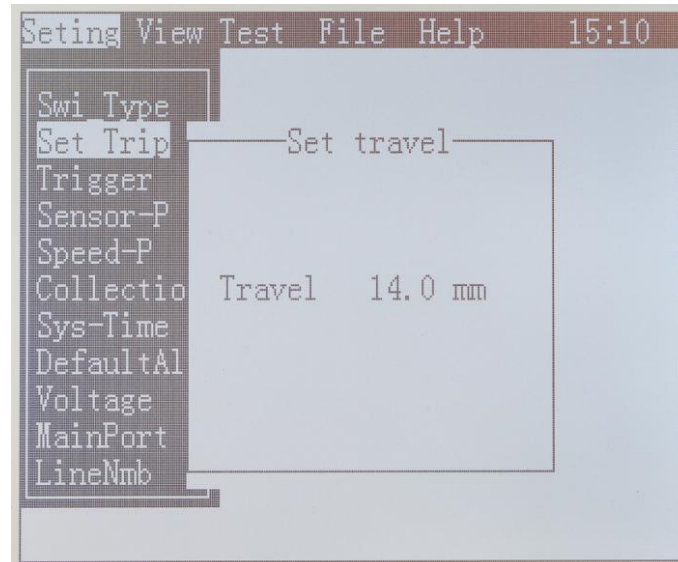

3) Setting of trigger mode: press **enter button** to enter, choose the trigger mode accordingly and press enter button to save.

① If you choose internal trigger mode, internal DC current will be outputted to control the opening (closing) status of the breaker.

② If you choose external trigger mode, external power supply operation will be employed. Then the apparatus will enter testing mode and automatically wait for closing or opening signal. Then electrically operate it manually.

③ If you choose **manual trigger mode**, you only need to connect fracture line, and there is no need to connect closing and opening controlling line. Set time in **acquisition time menu** to 3 second, setup will firstly enter testing mode and wait for signal, with manual operation or opening status. And this motion shall be completed in 3 seconds, otherwise, the apparatus will go

back automatically and there will be no testing data. Shown as follows:

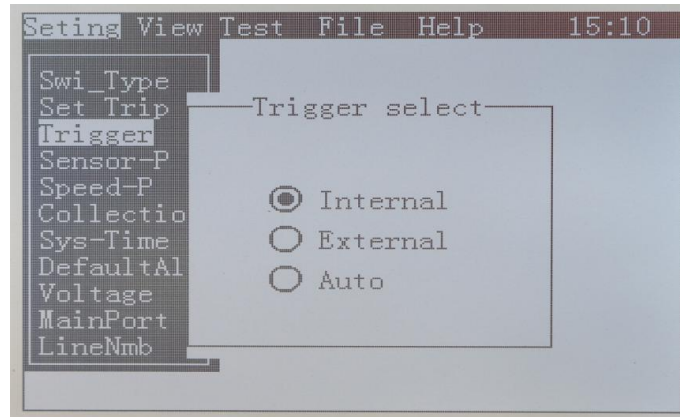

- 4) **Setting of sensors:** press **enter button** to enter. Press “↑” or “↓” to choose sensor. Choose 50mm sensor if vacuum can be installed with linear sensor. Choose 360-line rotating sensor or universal sensor if you cannot install linear sensor. Press **enter button** to save, shown as follows:

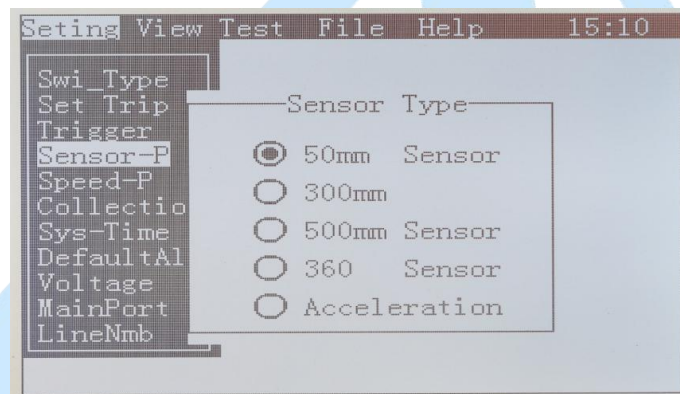

- 5) **Setting of speed definition:** press **enter button** to enter, then press “↑” or “↓” to select the needed speed. Press **setting button** to enter value before opening after closing of definition. After shadow of cursor appears, press “→” or “←” to adjust the size to the needed size and then press save button to save the value. If you do not know the definition of vacuum switch speed, select the first item. If it is sulfur hexafluoride switch, select the last definition of speed. Shown as follows:

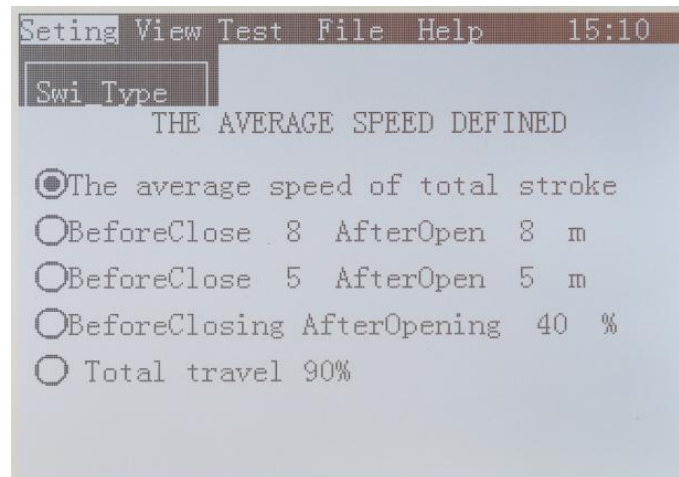

6) **Acquisition time setting:** press **enter button** to enter, and the default time is 0.5 second. If the **internal trigger mode** is chosen, there is no need to change this item. The acquisition time refers to the time period of voltage input. If the setting time is too long, the switch coil will be easily damaged. If the **manual trigger mode** is chosen, the acquisition time refers to the acquisition length of fracture signal, which is normally 3 seconds. Press “↑” or “↓” to set the length of time. **Note: after the experiment in **manual trigger mode**, please recover the time to 0.5 second, so that the voltage output time will not be too long to cause damage to the switch while conducting the **internal trigger mode**.** Shown as follows:

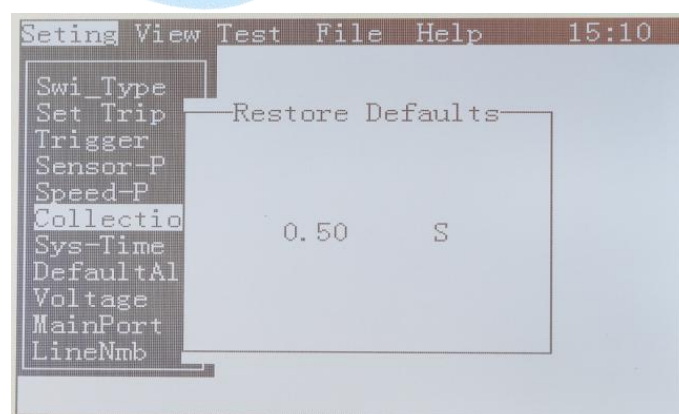

7) **System time setting:** System time setting: press the **enter button** to enter,

press "→" to enter the setting, then press "↑" or "↓" to set the current year, month, day and time. Press **enter button** to finish setting. Shown as follows:

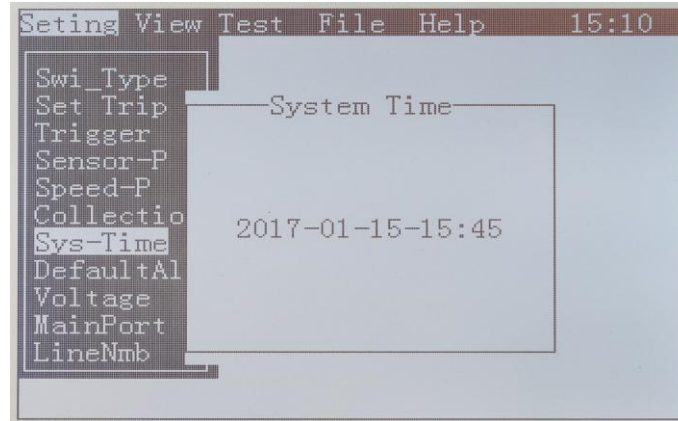

8) Voltage setting: Press **enter button** to enter, set the voltage required for the experiment through the "↑" or "↓" , shown as follows:

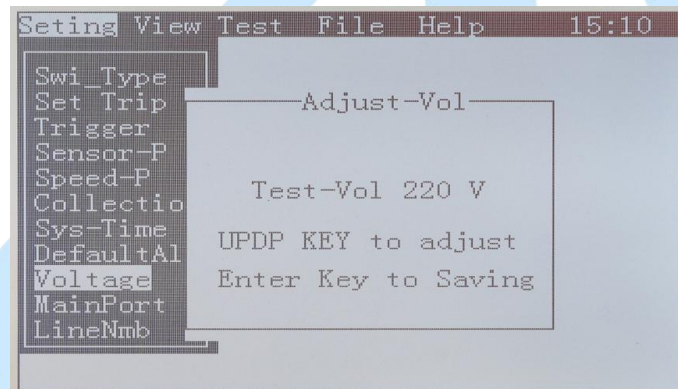

9) Main fracture setting: press **enter button** to enter, and the default main fracture is A1. Each fracture is independent to each other. Set the current testing fracture through the "↑" or "↓", and press **enter button** to save. Shown as follows:

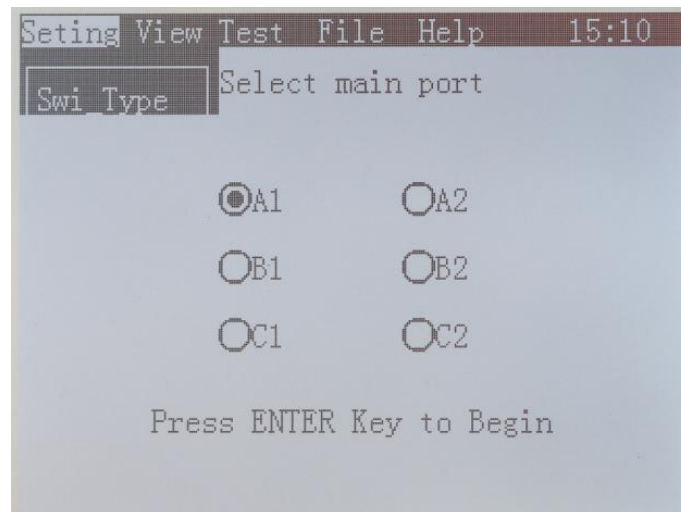

10) **Line number setting:** press **enter button** to enter. Set the required number or English through the "↑" or "↓", and press "→" and "←" to move the phase. Shown as follows:

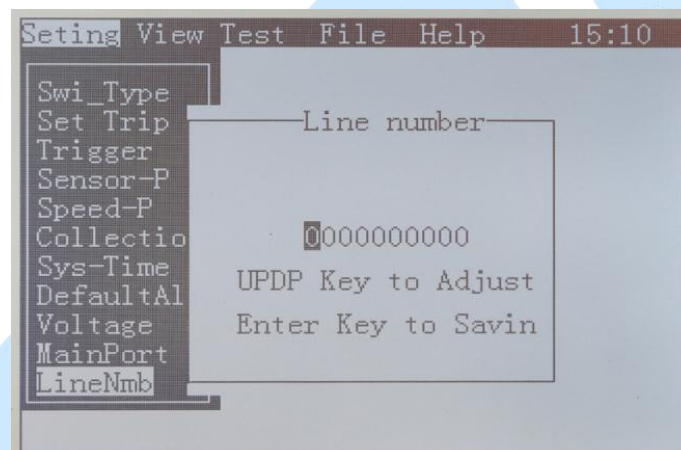

After all the settings are completed, press return key to return to the main interface.

2. Description of menu view:

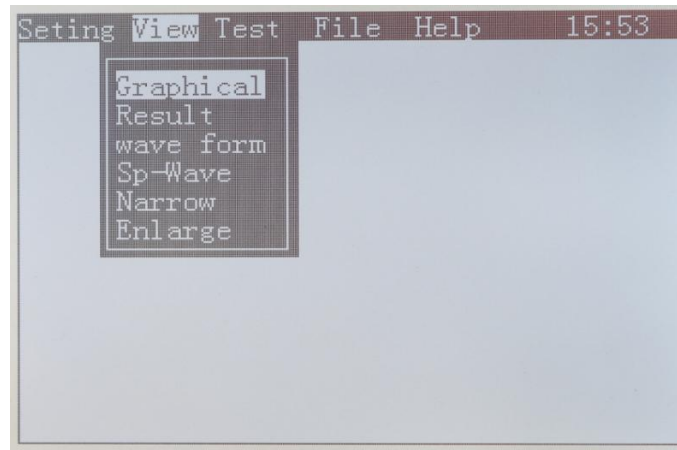

When the test is completed, view and analyze the current test data through this menu.

3. Description of menu testing

After the parameters have been set, perform the experiment in this menu.

Shown as follows:

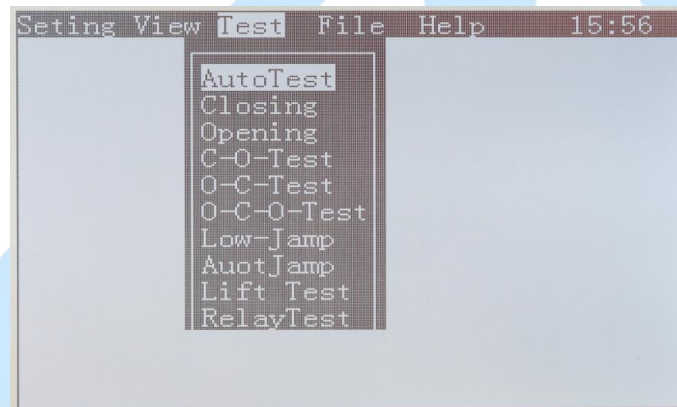

① **Automatic testing menu:** automatically determine the opening (closing) status, and make the corresponding action.

② **Closing testing menu:** closing controls the voltage output (red line positive and black line negative in internal trigger), to make the switch act. If the power supply controlled by opening is damaged, the opening motion can be performed by this function.

③ **Opening testing menu:** opening controls the voltage output (green

line positive and black line negative in internal trigger), to make the switch act. If the power supply controlled by closing is damaged, the closing motion can be performed by this function.

④ **Closing and opening testing menu:** the “closing-opening” experiment of the switch can be performed after the control time period is set “closing-t1-opening”, and the time value of one closing, one opening and one golden short of the switch can be obtained directly.

⑤ **Opening and closing testing menu:** the “opening-closing” experiment of the switch can be performed after the control time period is set “opening-t2-closing”, and the time value of one opening, one closing and no current of the switch can be obtained directly.

⑥ **Opening-closing and opening testing menu:** the “opening-closing-opening” experiment of the switch can be performed after the control time period is set “opening-t2-closing-t1-opening”, and the time value of one opening, one closing, two opening, one golden short and no current of the switch can be obtained directly.

⑦ **Manual low-jump menu:** do not connect the fracture signal line, and supply power directly to the opening (closing) brake coil to perform the test, while the voltage step can be set.

⑧ (8). **Automatic low-jump menu:** connect the fracture signal line, and set the voltage step, then the automatic voltage to find the minimum voltage for opening (closing).

⑨ **Life testing menu:** the opening and closing experiment of the switch

is automatically performed after the parameters setting.

- ⑩ **Contactor testing menu:** the special switch and contactor testing (closing maintains with power-on, and opening comes immediately after the power-off) regarding the same control point of opening and closing, is to connect the red line(positive) and black line(negative) of the internal trigger to the coil for testing.

4. Description of file menu

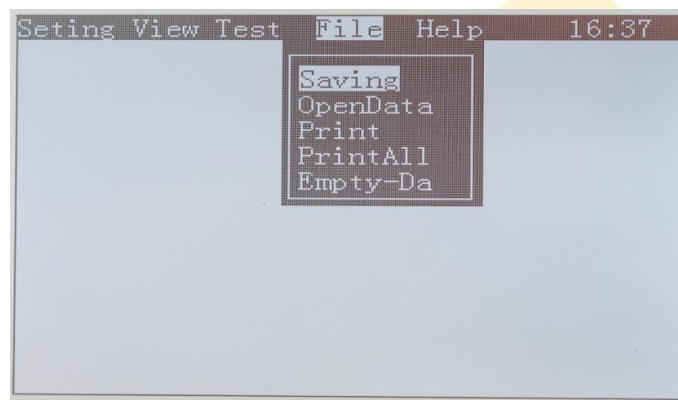

- ① **Data saving menu:** save the current testing data.
- ② **Data opening menu:** open the saved data.
- ③ **Printing menu:** print the current testing data.
- ④ **Integrated printing menu:** print all the data (graphics and data) for this test.
- ⑤ **Data clearance menu:** clear the current testing data (not the storage data), which equals to a screen clearance.

VII Method of operation

After setting all parameters, enter from **testing menu** and chose **automatic testing** menu, then press **enter button** to get to fracture status,

then press **enter button** to perform the testing. Shown as follows:

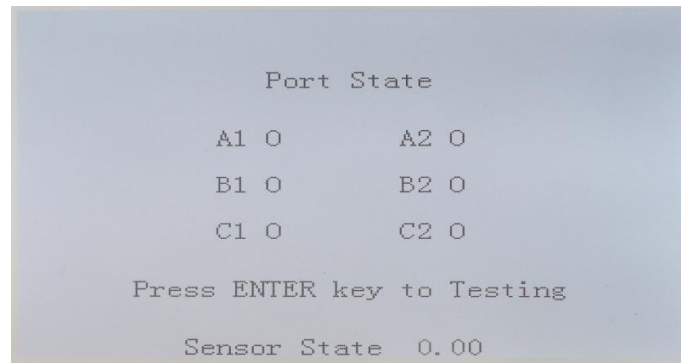

After the testing, if you want to view the testing data, press **enter button** to view the curve graph, and press **print button** to print the data; you can also select the **curve graph** or the **comprehensive data** in the **view menu** for a view. Testing data of closing shown as follows:

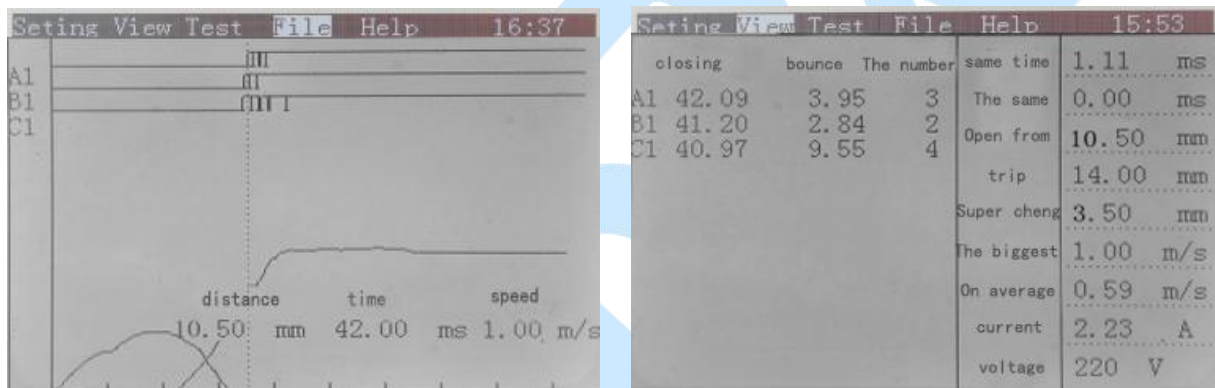

After the view or printing of closing data, press **return button**, and then press **enter button** to perform the opening testing. Testing data of opening shown as follows:

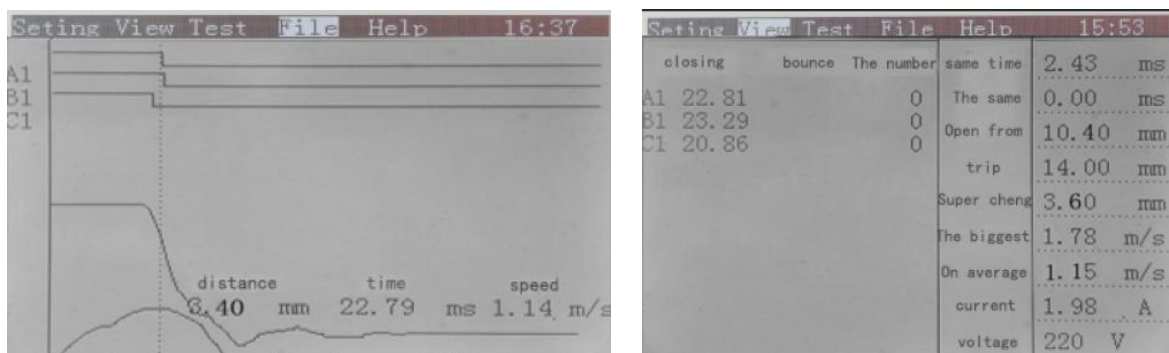

Press the **print button** to print the current data. To print all the data,

select the **integrated print** from the **file menu**.

VIII Term definition

1. Three-phase Un-synchronization : the maximum and the minimum between three phase opening (closing) of switch.
2. In-phase non-synchronization: switch above fracture 6, time difference of in-phase fracture opening (closing).
3. Bouncing time: accumulated time of all connecting, separation (bouncing) in the closing process of dynamic and static contact for switch.
4. Opening time: breaker at opening position, interval from the moment opening tripping electrified to the moment all arc contacts of different levels separate.
5. Closing time: breaker at opening position. Interval from the moment closing circuit is electrified to the moment all pole contacts connect.
6. Re-closing time: in re-closing cycling, it means the interval from the moment opening time starts to the moment all pole contacts connect.
7. Opening/closing speed: in a time when dynamic contact of switch connects with static contact, or in a distance where the average speed, take 10ms for example, it means the average speed in 10ms for opening and the average speed in the earlier 10ms for closing.
8. Opening Range: the distance from opening of switch to where dynamic contact starts to connect static contact.
9. The maximum opening (closing) speed: the maximum speed in opening (closing) instantaneous speed. Generally speaking, the value appears in

the moment that switch just open or close, which can be judged from speed and travel curve.

10. The average opening (closing) speed: the ratio of travel for switch dynamic contact in the whole operation process to time.

IX Troubleshooting method of the device

1. When the device is powered on, if the LCD screen keeps blind, please replace the power supply fuse, and if the screen is still blind after the replacement, please turn off the power supply immediately and return it to the factory for maintenance. Please do not open the apparatus panel for checking as there is high voltage inside, and please pay attention to safety.
2. Print is not displayed after the paper is replaced, because the paper is thermal paper, so please put the other side.
3. After plugging in the fracture line, the breaker shows opening status, while closing status is shown on one phase or three phases of the apparatus, there are two following cases:
 - 1) If the fracture line is pulled out and the apparatus still turns into opening status, use the universal meter buzz to check the fracture line whether there is short circuit or line connection error.
 - 2) If the fracture line is pulled out and the apparatus still turns into closing status, use the universal meter buzz to check the breaker whether there is electricity leakage. If there is electricity leakage, please do not connect other fractures to perform testing again, and only after the electricity

leakage is solved, it is possible to connect other fractures to perform testing. If there is no electric leakage, it is an instrument fault. A2 should be set as the main fracture before the test.

4. No motion of breaker: after connecting the testing line to perform the test, if the internal trigger control line is connected correctly, the apparatus issues the opening and closing orders to the breaker where there is no motion. First, check whether the voltage setting of the apparatus is accurate, then use the multimeter to play in the DC shift (DC 1000V) and check whether the power supply output is normal. Performing the testing in the **energy storage control** of the **testing menu** to check whether there is voltage output. Press “→” button for closing energy storage, and connect the red line and black line to the multimeter for testing. Press “←” button for closing energy storage, and connect the green line and black line to the multimeter for testing. If the voltage output is normal, please check the control circuit of the break and whether the system is jammed. If there is no voltage output, please return it to the factory for maintenance.

X Daily maintenance

1. The apparatus is a precious device, so please keep it properly and avoid striking and hitting. While operated outside, it should be placed in shadow to keep the liquid crystal screen from exposure to sunshine.
2. If not used, it should be kept in the temperature from $-10 \sim 40$ °C and in ventilating and non-corrosive air with its relative humidity no more than

80%. In wet seasons, if not used for a long time, it should be powered on for half an hour once per month.

XI Energy storage instructions

1. Connect the energy storage power cord first.Red is positive, black is negative
2. If the energy storage voltage is reset after the power is turned on,After setting, please turn off the power of the instrument before turning it on.
3. When the energy storage is in place, please release the "energy storage switch".turn off the energy storage power,Otherwise, long-term voltage output will damage the instrument.
4. If there are any other abnormalities in the energy storage process (odor, smoke, energy storage does not work), please turn off the power of the instrument, and find out the fault before using it again.

XII Packing list

NO.	ITEM	Remarks	unit	Quantity
1	host		Pcs	1
2	main chassis		Pcs	1
3	Accessory box		Pcs	1
4	fracture line	10M	Pcs	2
5	Close and break the control line	5.5M	Pcs	1
6	Energy storage test	5.5M	Pcs	1

	line			
7	Short wires	1M	Pcs	1
8	Ground wire	3M	Pcs	1
9	The power cord	10A	Pcs	1
10	insurance	10A	Pcs	2
11	Printing paper		Pcs	2
12	Linear sensor	50mm	Pcs	1
13	Rotary sensor	360°	Pcs	1
14	gimbal		Pcs	1
15	Speed sensor adapter		Pcs	1
16	The screwdriver		Pcs	1
17	manual		Pcs	1
18	Test Report		Pcs	1
19	Certificate/warranty card		Pcs	1