

**ZXET3005 Digital
Ground Resistance Tester**



Table of contents

Safety Instructions	1
I.Intruduction	2
II. Technology Specification	3
III.Product Photograph	6
IV.Display	7
V. Working Principle	8
VI. Operation	9
1.Basic Operation.....	9
2.Test.....	10
3.Grounding voltage test.....	12
VII. Battery management	13
VIII. Package	13



Safety Instructions

- The instrument is designed, manufactured and inspected according to IEC61010 safety standard.
- **The RS232 interface and internal circuit of the instrument is non-isolated . It is forbidden to connect the computer when testing voltage, otherwise the instrument will be burned or electric shock accident will occur. The voltage test line must first be pulled out of the meter before connecting to the RS232 data port to read data from the computer. Online monitoring in manuals is not applicable to monitoring voltage.**
- In any case, the use of this instrument should pay special attention to safety, pay attention to the body of the instrument labels and symbols.
- It shall make sure that tester and accessories are in good condition before use; it can be used only when there is no damaged, naked or broken part in testing wires or insulation layer. During the measurement, it is forbidden to contact exposed conductors and the circuit being measured.
- Please confirm the location of the **FUNCTION** knob before measuring.
- Confirm that the connecting plug of the wire has been tightly inserted into the instrument interface.
- Do not apply more than 100 V AC or DC voltage between the test end and the interface, otherwise the instrument may be damaged.
- Do not measure in flammable places, sparks may cause explosions.
- Do not place in high temperature and humidity, condensation places and direct sunlight for long time to store and store instruments.
- If the instrument is damp, first dry it and store.
- When charging the battery, please confirm that the test line has been removed from the meter and the **FUNCTION** knob is in the "**OFF**" position.
- The meter shows a low battery voltage symbol and should be charged to the battery in time.
- If you don't use this meter for a long time, please charge the battery every 3 months.
- Pay attention to the measuring range and use environment specified in this instrument.
- This measuring device is only to be used, disassembled, adjusted and repaired by qualified personnel with authorization.
- For the reason of this instrument, if it is dangerous to continue to use it, it should be stopped immediately and sealed up immediately, which should be handled by authorized authority.
- Safety warning signs in meters and manuals shall be operated in strict accordance with the contents of this manual.

I. Introduction

The **ZXTE3005 earth resistance and soil resistivity tester** is specially designed and manufactured for **ground resistance**, The testing current reaches 20mA. The digital and micro-processing technology, precision 3-wire method and simple 2-wire method are used to measure ground resistance, importing FFT (Fast Fourier Transform) technology, AFC (Automatic Frequency Control) technology, which is widely used in electric power, telecommunications, meteorology, oil field, construction, lightning protection, industrial electrical equipment and other earth resistance, earth voltage measurement.

The ZXTE3005 earth resistance tester is composed of **host machine, data software, test line, auxiliary grounding rod, communication line** and so on. The special toolbox design of the main engine uses polypropylene plastics as raw materials and adds a new type of composite filler for one-time injection molding. It has the advantages of low density, strength, stiffness, hardness, abrasion resistance, heat resistance and insulation. The box can withstand about 200 kg of pressure to ensure high precision, high stability and high practicability of various environmental tests. The host of large LCD display with backlight, bar graph indicating that can be seen clearly, it can store 2000 sets of data. Through data software, it can realize the functions of reading, consulting, saving, reporting and printing historical data.

II. Technology Specificaton

Function	Grounding resistance, low resistance test, grounding voltage test.
Power	DC 7.4V 1.8Ah rechargeable Li-battery, battery full charge time 8h.
Back light	Controllable white screen backlight, suitable for use in dark field.
Testing method	Precision three wire method and simple two wire method to test grounding resistance
Measure method	Earth Resistance: rated current change-pole method, Earth Voltage: average rectification(between P(S)-ES)
Range	23 wire method for measuring ground resistance (R) : 0.000Ω ~ 3000Ω Grounding voltage : AC 0.0 ~ 100.0V(50Hz/60Hz)
Max. resolution	0.001Ω; 0.1V
Accuracy	Grounding Resistance: +2% rdg+5dgt Note: 1. Auxiliary Grounding Resistance 100_+5%, Ground Voltage < 5V 2. Additional error (<5%rdg+5dgt) at 5V interference voltage Grounding voltage : ±2%rdg±3dgt
testing volta wave shape	sine wave
Testing frequency	128Hz/111Hz/105Hz/94Hz(Automatic frequency selection)
Short circuit test current	AC 20mA max
Open circuit test voltage	AC 40V max
LCD	6" LCD display, white screen backlight
LCD size	128mm×75mm
LCD display size	124mm×67mm
Testing indication	LED flashing indication in measurement.LCD count down.Progress bar chart indication

size	Host machine : Length Width Height 320mm×275mm×145mm
	Outer size : Length Width Height 400mm×245mm×335mm
Standard test wire	Total 3pcs : red wire 20m , yellow wire 10m , green wire 5m, each 1pcs
simple test wire	Total 2pcs : red wire 1.6m , black wire 1.6m each 1pcs
auxiliary grounding rod	2 pcs : ϕ 10mm×150mm
test time	Ground voltage: approx 2times/sec ; ground resistance : approx 7times/sec
test times	5000times above (short circuit test, test 1 time,Stop for 30 seconds and retest.)
circuit voltage	AC 100V below test
communication port	With RS232 interface, storage data can be uploaded to the computer and saved to print.
communication wire	RS232 communication wire 1pcs, length 1.5m
Data HOLD	The "HOLD" symbol indicates data is kept.
data save	2000 SET , "MEM" Storage instructions ,display "FULL" Indicates that the storage is full.
data read	READ key indicates to read data
overflow display	exceeding range low function: "OL" icon display
Interface test	Recognize interference signal automatically, "NOISE" icon display when interference voltage exceed 5V
Alarm function	When measuring value exceeds alarm setting value, there is "Toot-toot-toot" alarm hint
battery voltage	When low battery, battery voltage low icon will display, reminding to charging battery.
Automatically power off	Turn off automatically after standby 15 minutes.
working current	Standby: about 25mA (Backlight shut off) ; backlight : 25mA Max(only backlight consumption) ; Measurement: about 150mA (Backlight shut off)
weight	Host machine : 2.645kg(with battery)
	Total weight : 5.95kg(with package)

Tool box	The military toolbox is designed to support pressure 200kg.
Working humiture	-10°C ~ 40°C ; 80%rh below
Storage humiture	-20°C ~ 60°C ; 70%rh below
Overload protection	Measure ground resistance : C(H)-E、 P(S)-ES between each port AC 280V/3sec
Insulation resistance	20MΩ above(between circuit and shell 500V)
Withstand voltage	AC 3700V/rms(between circuit and shell)
Electromagnetic features	IEC61326(EMC)
Protection type	IEC61010-1(CAT III 300V、 CAT IV 150V、 pollution class2) ; IEC61010-031 ; IEC61557-1(ground resistance) ; IEC61557-5(soil resistivity) ; JJG 366-2004(ground resistance meter).

III. Product photograph



IV. Display

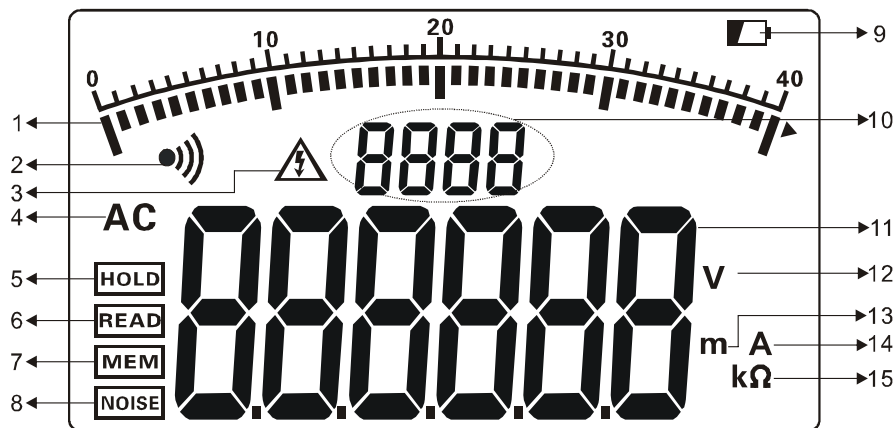

1. Test progress bar chart (showing progress of the test, dynamic display).
2. Alarm indicator (when the alarm function is activated, the alarm is displayed when the critical threshold is over).
3. Over voltage indication (indicated by the test voltage exceeding 30V, caution safety)
4. Exchange instructions.
5. Data holding instructions (press **MEM** key to display data while maintaining data).
6. Data access instruction (long press **MEM** key for 3 seconds to enter data access).
7. Data storage instructions (press **MEM** key to hold data while displaying data while storing data).
8. Interference signal indication (interference voltage exceeds 5V display).
9. Battery low indication.
10. Storage data group number indication.
11. Test data (6 bit).
12. Voltage unit symbol.
13. Length unit symbol.
14. Current unit symbol.
15. Resistance unit symbol.

V. Working principle

1. The earth voltage is measured by the average rectification method.
2. The grounding resistance value is measured by the rated electrorheological pole method (suitable for accurate measurement of single-point grounding system), i.e. the rated current I flowing between the E grounding electrode and the $C(H)$ current pole of the measuring object, the potential difference V between the E grounding electrode and the $P(S)$ voltage pole is calculated, and the grounding resistance R is calculated according to the formula $R=V/I$.

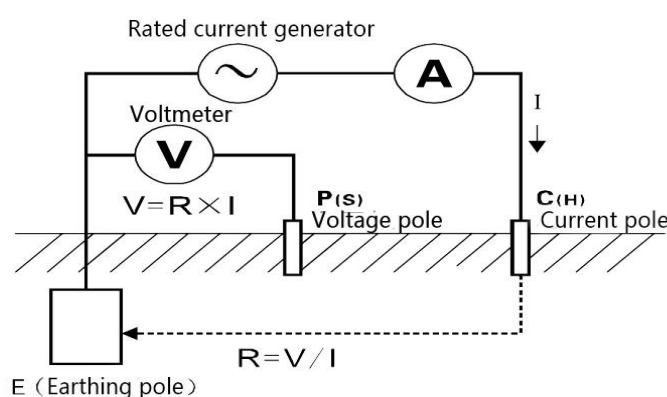

3. The working errors (**B**) of the above methods are calculated from the inherent errors (**A**) and the variation errors (**E_i**) of the instruments used.

$$B = \pm (|A| + 1.15 \times \sqrt{E_2^2 + E_3^2 + E_4^2 + E_5^2})$$

A: inherent error

E₂: changes in power supply voltage variations

E₃: variation of temperature variation

E₄: changes caused by disturbance voltage changes

E₅: changes in resistance of contact electrodes



VI. Operation

1. Basic Operation

Turn the **FUNCTION** function knob to realize the switch machine, and the knob indicates the "OFF" position is turned off. This instrument shuts down automatically 15 minutes after the start-up. After the automatic shut-down, the function knob will be transferred to the "OFF" position and restart.

After power on, if the LCD display battery voltage low sign "  ", indicating that the battery is insufficient, please charge the battery according to the instructions. Battery power is sufficient to ensure measurement accuracy.

After starting, press the  key to turn on or turn off the backlight. The backlight function is suitable for dim places. The default backlight is turned off every time.

After power on, the **FUNCTION** function selection knob is turned to the corresponding position, short press "AL" key can turn on or off the alarm function, long press "AL" key (about 3 second   enter the alarm threshold setting, press " " key to change the current number size, short press "AL" key to move the cursor, and long press "AL" key to save and exit. When the measurement value is greater than the critical set value while the alarm function is turned on, the instrument will flicker and display the sign of " **Dou-Dou-Dou-Dou** and send out the alarm sound.

In test mode, press "MEM" key to lock the current display data, display "HOLD" and "MEM" symbols, and automatically number storage, if the storage is full, the instrument shows "FULL" symbols. Then press the "MEM" button to unlock.

In test mode, press "MEM" key (more than 3 seconds) for data access, press " " or " " key to lookup data with step value  1, hold " " or " " key to lookup data with step value of 10, and press "SET" key. Check the values of **rC**, **rP** and **a**, then press "MEM" to exit when the currently data group is grounding resistance data or soil resistivity data.

If there is no stored data during the visit, LCD will display "-----" and see the top right picture.

In the data access state, press the "CLR" key to enter the data deletion, press the "CLR" key to select "NO" or "YES", select "NO" and then press the "MEM" key not to delete and return to the data access state, select "YES" and then press the "MEM" key to delete the stored data, after deletion LCD display "----". Data deletion function is to delete all stored data at one time, after deletion can not be restored, please operate with caution.

The data stored in the instrument can be uploaded to the computer. Connect the RS232 communication line between the computer and the instrument, the instrument boots up, running data software, if the software shows that the serial port is opened

and connected successfully, you can read the stored historical data, upload the computer and save.

Data software has the functions of reading, accessing, saving and printing historical data.

2. Test

Three-wire test grounding resistance

	<p>When testing the grounding resistance, first confirm the grounding line to the ground voltage value must be below 20V, if the grounding voltage is above 5V, the instrument shows NOISE symbols, at this time the grounding resistance measurement may produce errors, at this time will be measured grounding body equipment power off, so that the grounding voltage drops after Then the grounding resistance test is carried out.</p>
--	-----------------------------------------------------------------------------------------------------------------------------------------------------------------------------------------------------------------------------------------------------------------------------------------------------------------------------------------------------------------------------------------------------------------------------------------------------

Three-wire test: From the object under test, the P (S) and C (H) auxiliary grounding rods are embedded in the earth in a straight line. The grounding test lines (green, yellow and red) are connected from the E, P (S) and C (H) interfaces of the instrument to the tested grounding electrode E, auxiliary voltage pole P (S) and auxiliary current pole C (H)

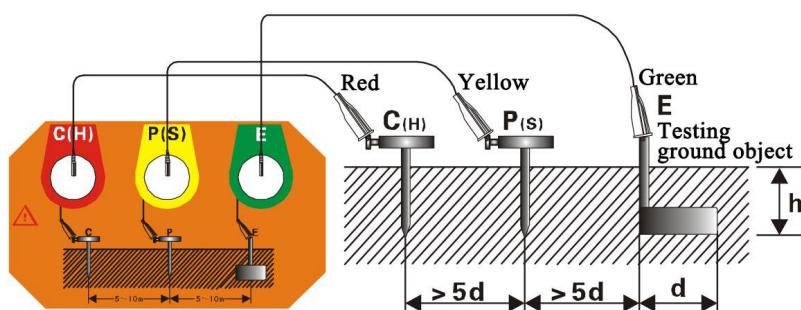

After connecting the test line, first turn the **FUNCTION** function selection knob to the "REARTH" position, enter the grounding resistance test mode, press the "TEST" button to start the test, there are countdown instructions and test progress bar chart instructions during the test process, and display stable data after the test, that is, the grounding resistance value **R** of the grounding body under test.

	<p>The distance between the measured grounding body E and the current electrode C (H) should be at least five times the depth (h) of the grounding body buried underground, or five times the length (d) of the grounding body buried underground. The total grounding resistance of a complex grounding system is measured, and the distance of D is the</p>
--	---------------------------------------------------------------------------------------------------------------------------------------------------------------------------------------------------------------------------------------------------------------------------------------------------------------------------------------------------------------

	distance of the maximum diagonal of the grounding system.
	When testing, the test lines can not be entangled with each other, otherwise the test accuracy may be affected.

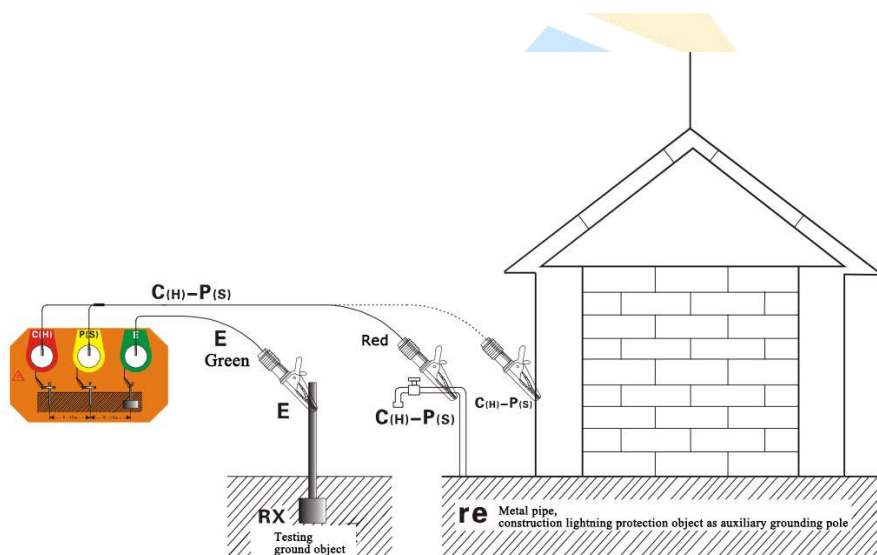
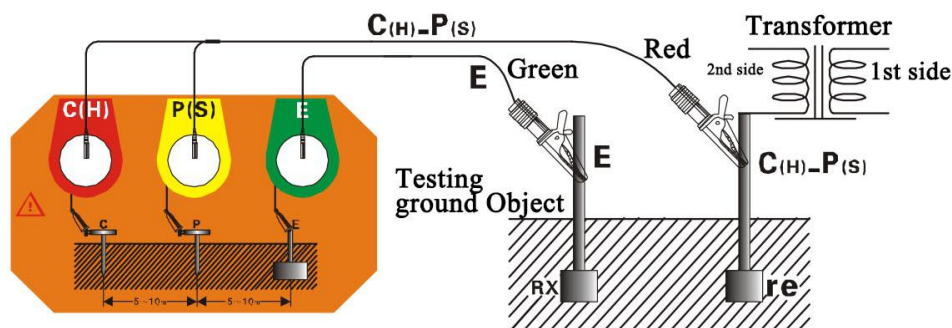

The instrument reading is the sum of the grounding resistance value of the grounding body measured and the grounding resistance value of the commercial grounding body.

$$R = RX + re$$

Among them:

R - reading values for instruments;

RX is the grounding resistance of the grounding body under test.

re - Grounding resistance of common grounding elements such as commercial power systems.

Then, the grounding resistance of the grounding body under test is:

$$R_x = R - re$$

	An auxiliary grounding rod is needed for grounding voltage test.
	As long as the instrument is connected to the earth through the test line and auxiliary grounding rod, the other test lines of the instrument interface can not be connected to the L and N lines of commercial power supply, otherwise the leakage will occur and the circuit breaker may start up, which is dangerous.
	Grounding voltage test should not exceed 100V.
	Can not be used for commercial voltage testing, otherwise it will damage the instrument.

3. Grounding voltage test

Grounding voltage: that is, the potential difference between the shell, grounding wire and grounding body of the grounding equipment and the zero potential point when the grounding fault occurs. The grounding voltage refers to the earth as the reference point, and the potential difference between the earth and the earth as the zero potential point.

An auxiliary grounding rod should be used in grounding voltage test. The difference between the grounding voltage test and commercial AC voltage test should be noted. Refer to the following figure: After the instrument, auxiliary grounding rod and test line are connected, switch the FUNCTION function conversion knob to the "EARTH VOLTAGE" position, start to test the grounding voltage, LCD display the test results.

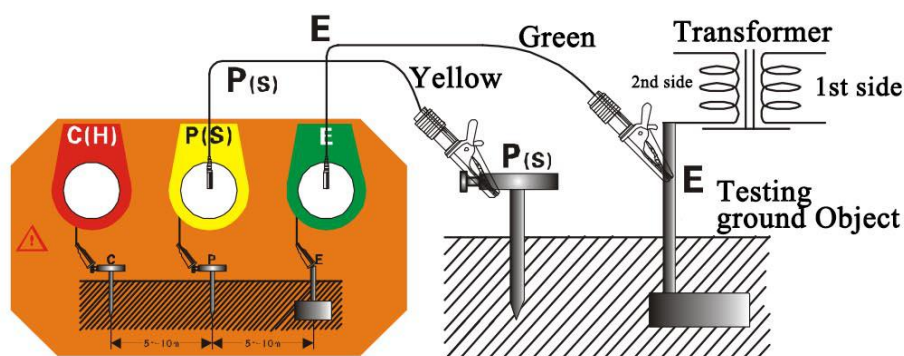

VII. Battery management



- **charge the battery in time, do not use the meter for a long time, charge the battery once every 3 months.**
- **When charging, the indicator on the charger is bright red, full battery in bright green.**
- **Must use standard chargers to charge.**

1. when the battery voltage is insufficient, please charge in time, charging time is about 1 hours.
2. To replace the battery, open four screws from the bottom of the toolbox, remove the instrument panel, and replace the battery. If the user is unable to replace the battery, please contact the manufacturer.
3. rotating **FUNCTION** function knob to see if it can start normally. If you can't turn on the machine, press the second step to re-operate.

VIII. Package

Instrument	1set
Tools box	1pcs
1 auxiliary grounding wire	4pcs
Test wire	4pcs (red 20m ; yellow 10m ; green 10m ; black 20m)
Simple testing wire	2pcs (red 1.6m ; black 1.6m)
Charger, Charger	1set
Data Software (CD-ROM)	1pcs
RS232 communication cable	1pcs
User manual, warranty card, qualification	1pcs

- Company is not responsible for other losses arising from use.
- The contents of this user manual can not be used as a justification for using the product for special purposes.
- The company reserves the right to modify the contents of user manuals. If there is any amendment, no further notice will be given.