

ZXET3008 Double Clamp Ground Resistance Tester



Table of contents

Safety Instructions.....	2
I.Intruduction.....	3
II. Technology Specification.....	4
III.Product Photograph.....	9
IV.Display.....	10
V. Working Principle	11
VI. Operation.....	14
1.Basic Operation.....	14
2. Test.....	15
VII. Battery management.....	27
VIII. Package.....	27



Safety Instructions

- The instrument is designed, manufactured and inspected according to IEC61010 safety standard.
- **The USB interface and internal circuit of the instrument is non-isolated . It is forbidden to connect the computer when testing voltage, otherwise the instrument will be burned or electric shock accident will occur. The voltage test line must first be pulled out of the meter before connecting to the USB data port to read data from the computer.**
- In any case, the use of this instrument should pay special attention to safety, pay attention to the body of the instrument labels and symbols.
- Please mind the arrow current direction on the clamp
- It shall make sure that tester and accessories are in good condition before use; it can be used only when there is no damaged, naked or broken part in testing wires or insulation layer. During the measurement, it is forbidden to contact exposed conductors and the circuit being measured.
- Please confirm the location of the **FUNCTION** knob before measuring.
- Confirm that the connecting plug of the wire has been tightly inserted into the instrument interface.
- Do not apply more than 100 V AC or DC voltage between the test end and the interface, otherwise the instrument may be damaged.
- Do not measure in flammable places, sparks may cause explosions.
- Do not place in high temperature and humidity, condensation places and direct sunlight for long time to store and store instruments.
- If the instrument is damp, first dry it and store.
- When charging the battery, please confirm that the test line has been removed from the meter and the **FUNCTION** knob is in the "**OFF**" position.
- The meter shows a low battery voltage symbol and should be charged to the battery in time.
- If you don't use this meter for a long time, please charge the battery every 3 months.
- Pay attention to the measuring range and use environment specified in this instrument.
- This measuring device is only to be used, disassembled, adjusted and repaired by qualified personnel with authorization.
- For the reason of this instrument, if it is dangerous to continue to use it, it should be stopped immediately and sealed up immediately, which should be handled by authorized authority.
- Safety warning signs in meters and manuals shall be operated in strict accordance with the contents of this manual.

I. Introduction

The ZXTE3008 double clamp earth resistance tester is specially designed and manufactured for ground resistance, soil resistivity, ground voltage, grounding lines leakage current, AC and DC resistance in combination with the new lightning-proof ground resistance testing standard. The testing current reaches 20mA. Comply with digital and micro-processing technology, precision 4-wire method, 3-wire method and simple 2-wire, selection method, and double clamps method are used to measure vast ground resistance, inputting FFT (Fast Fourier Transform) technology, AFC (Automatic Frequency Control) technology, with a unique function of anti-interference capability and the ability to adapt to the environment, consistency of repeat testing, to ensure high precision, high stability and reliability for prolonged measure, which is widely used in electric power, telecommunications, meteorology, oil field, construction, lightning protection, industrial electrical equipment and other earth resistance, soil resistivity, earth voltage, AC voltage measurement

ZXTE3008 Earth Resistance Tester also named: double clamp Earth Resistance Tester, double clamp grounding resistance Tester, The tester is composed of host machine, current clamps(2pcs), data software, test line, auxiliary grounding rod, communication line and so on. The special toolbox design of the main engine uses polypropylene plastics as raw materials and adds a new type of composite filler for one-time injection molding. It has the advantages of low density, strength, stiffness, hardness, abrasion resistance, heat resistance and insulation. The box can withstand about 200 kg of pressure to ensure high precision, high stability and high practicability of various environmental tests. The host of large LCD display with backlight, bar graph indicating that can be seen clearly, it can store 2000 sets of data. Through data software, it can realize the functions of reading, consulting, saving, reporting and printing historical data.

II. Technology Specification

Function	Grounding resistance, soil resistivity, DC resistance, conduction resistance and equipotential connection resistance test, grounding AC voltage test, AC test, leakage AC test.
Power	DC 9V(Zi-Mn dry battery R14S 1.5V 6 PCS, continuous standby for 300 hours)
Back light	Controllable white screen backlight, suitable for use in dark field.
Testing method	precision 234 wire method test grounding resistance, selection method, double clamp to measure grounding resistance
Measure method	234 wires testing method: Pole-changing method, short circuit testing current 20mA Max.
	Selection method: Pole-changing method, short circuit testing current 20mA Max.
	Double clamp method: non-contact type transformer, testing current 1mA Max.
	Soil resistivity: quadrupole method (Winner method) DC Resistance: Pole Changing Method AC Current: Average Rectifier (Clamp) Ground Voltage: Average Rectifier (P(S)-ES Interface)
Range	Measuring grounding resistance (Re) and DC resistance by two, three and four-wire method: 0.000~30000Ω Selective Method for Measuring Grounding Resistance (Re):0.00~3000 Measurement of Grounding Resistance (Re):0.01 Ω ~200 Ω by Double-clamp Method Soil resistivity (ρ): 0.00Ωm-9000 kΩm Grounding Voltage (50Hz/60Hz): AC 0.0-100.0V AC Current (50Hz/60Hz): AC 0.00mA-600.0A
Max. resolution	Measuring grounding resistance (Re) and DC resistance by 234 method: 0.001Ω (0.000Ω ~ 29.999Ω) 0.01Ω (30.00Ω ~ 299.99Ω) 0.1Ω (300.0Ω ~ 2999.9Ω) 1Ω (3000Ω ~ 30000Ω)
	Selection method: 0.01Ω (0.00Ω ~ 29.99Ω) 0.1Ω (30.0Ω ~ 299.9Ω) 1Ω (300Ω ~ 3000Ω)
	Double clamp method: 0.01Ω (0.01Ω ~ 0.99Ω)

	<p>0.1Ω (1.0Ω ~ 29.9Ω) 1Ω (30Ω ~ 200Ω)</p> <p>Soil resistivity: 0.01Ωm (0.00Ωm ~ 99.99Ωm) 0.1Ωm (100.0Ωm ~ 999.9Ωm) 1Ωm (1000Ωm ~ 9999Ωm) 10Ωm (10.00kΩm ~ 99.99kΩm) 100Ωm (100.0kΩm ~ 999.9kΩm) 1kΩm (1000kΩm ~ 9000kΩm)</p> <p>Grounding voltage(50Hz/60Hz): 0.1V</p> <p>AC(50Hz/60Hz): 0.01mA</p>
Accuracy	<p>234 wire method for measuring ground resistance (R) DC Resistance :</p> <p>±2%rdg±0.05Ω (0.000Ω ~ 29.999Ω) ±2%rdg±3dgt (30.00Ω ~ 299.99Ω) ±2%rdg±3dgt (300.0Ω ~ 2999.9Ω) ±4%rdg±3dgt (3.000kΩ ~ 30.00kΩ)</p> <p>Note: 1. Additional error of rC Max or rP Max is <5% rdg+5 dgt. (rC max: 4K + 100R < 50k, rP max: 4K + 100R < 50k) 2. The additional error and 5 V interference voltage is <5%rdg+5 dgt.</p>
	<p>Selection method(Re) :</p> <p>±2%rdg±5dgt (0.00Ω ~ 29.99Ω) ±2%rdg±3dgt (30.0Ω ~ 299.9Ω) ±2%rdg±3dgt (300Ω ~ 3000Ω)</p>
	<p>Double clamp grounding resistance :</p> <p>±10%rdg±5dgt (0.01Ω ~ 100Ω) ±20%rdg±5dgt (101Ω ~ 200Ω)</p>
	<p>Soil resistivity(ρ): according to the accuracy (ρ=2πaR a:1 m ~ 100m ; π=3.14) Grounding voltage (50Hz/60Hz) : ±2%rdg±3dgt AC (50Hz/60Hz) : ±2%rdg±3dgt</p>
Testing voltage wave shape	sine wave
Testing frequency	128Hz/111Hz/105Hz/94Hz(Automatic frequency selection)
Short circuit test current	AC 20mA max
Open circuit test voltage	AC 40V max

Electrode spacing	1m ~ 100m
Shift	Grounding resistance : 0.000Ω ~ 30000Ω Full automatic shift
	Soil resistivity : 0.00Ωm ~ 9000kΩm Full automatic shift
LCD	6-bit LCD display, white screen backlight
LCD size	128mm×75mm
LCD display size	124mm×67mm
Testing indication	LED flashing indication in measurement. LCD count down. Progress bar chart indication
Charging indication	When charging, the indicator on the charger is bright red, full of bright green.
Size	Host machine : Length Width Height 320mm×275mm×145mm
	Current clamp : Length Width Height 220mm×100mm×27mm
Standard test wire	Total 4pcs : red wire 15m , black wire 15m , yellow wire 10m , green wire 10m, each 1pcs
Simple test wire	Total 2pcs : red wire 1.6m , black wire 1.6m each 1pcs
Auxiliary grounding rod	4 pcs : φ10mm×150mm
Current clamp	Total 2pcs, CT1 connect Red-black port, CT2 connect Blue-black port,
Clamp diameter	φ52mm
Current clamp turn ratio	1000:1
Current clamp wire length	2 meters
Test time	AC: approx 2times/sec; Ground voltage : approx 2times/sec ; ground resistance : approx 7times/sec ;
Test times	5000times above (short circuit test, test 1 time, Stop for 30 seconds and retest.)
Circuit voltage	AC 100V below test
Communication port	With USB interface, storage data can be uploaded to the computer and saved to print.

Communication wire	USB communication wire 1pcs, length 1.5m
Data HOLD	The "HOLD" symbol indicates data is kept.
Data save	2000 SET , "MEM" Storage instructions , display "FULL" Indicates that the storage is full.
Data read	the "READ" symbol indicates look up data
Overflow display	Exceeding measuring range overflow function: "OL" icon display
Interface test	Recognize interference signal automatically, "NOISE" icon display when interference voltage exceed 5V
Current clamp low current direction	When the current signal received by the CT2 clamp is lower than that by the selective method or the double clamp method. At 0.5mA, the  sign is displayed, and the clamp of CT2 current clamp should be checked at this time. Direction of entry
Interference test	Automatically recognize interference signal, when interference voltage over 5V, display "NOISE"
Auxiliary grounding test	Able to measure auxiliary earth resistance, 0.00K Ω -30000 Ω (100R+rC<50k Ω , 100R+rP<50k Ω)
Alarm function	When measuring value exceeds alarm setting value, there is "DU-DU-DU" alarm remind
Battery voltage	When low battery , battery voltage low icon will display, reminding to charging battery.
Automatically power off	Turn off automatically after standby 15 minutes.
Working current	Standby: about 25mA (Backlight shut off) ; backlight : 25mA Max(only backlight consumption) ; Measurement: about 150mA (Backlight shut off)
Weight	Host machine : 2.66kg(with battery)
	Total weight : 7.87kg(with testing wires, grounding rod, package)
Tool box	The military toolbox is designed to support 200kg.
Working humiture	-10°C ~ 40°C ; 80%rh below
Storage humiture	-20°C ~ 60°C ; 70%rh below
Overload protection	Measure ground resistance: C(H)-E、 P(S)-ES between each port AC 280V/3sec

Insulation resistance	20M Ω above(between circuit and shell 500V)
Withstand voltage	AC 3700V/rms(between circuit and shell)
Electromagnetic features	IEC61326(EMC)
Protection type	IEC61010-1(CAT III 300V、CAT IV 150V、pollution class2) ; IEC61010-031 ; IEC61557-1(ground resistance) ; IEC61557-5(soil resistivity) ; JJG 366-2004(ground resistance meter); JJG1054-2009(clamp grounding resistance).

III. Product photograph



IV. Display

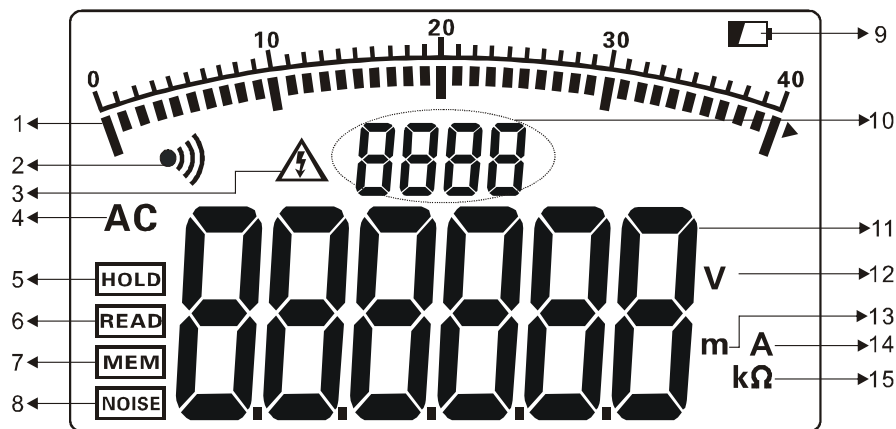

1. Test progress bar chart (showing progress of the test, dynamic display).
2. Alarm indicator (when the alarm function is activated, the alarm is displayed when the critical threshold is over).
3. Over voltage indication (indicated by the test voltage exceeding 30V, caution safety)
4. Exchange instructions.
5. Data holding instructions (press **MEM** key to display data while maintaining data).
6. Data access instruction (long press **MEM** key for 3 seconds to enter data access).
7. Data storage instructions (press **MEM** key to hold data while displaying data while storing data).
8. Interference signal indication (interference voltage exceeds 5V display).
9. Battery low indication.
10. Storage data group number indication.
11. Test data.
12. Voltage unit symbol.
13. Length unit symbol.
14. Current unit symbol.
15. Resistance unit symbol.

V. Working principle

1. Three-wire method and four-wire method are used to measure grounding resistance by rated electrorheological pole method (suitable for accurate measurement). Quantitative single-point grounding system, i.e. flowing AC rated current between E grounding electrode and C(H) current electrode of the measuring object. Current I , calculate the potential difference V between E grounding electrode and P(S) voltage electrode, and calculate the grounding electricity according to formula $R=V/I$. Resistance R . In order to ensure the accuracy of the test, the 4-line method is adopted to increase ES-assisted polarity. ES and E are clamped at the same point of the grounding body.

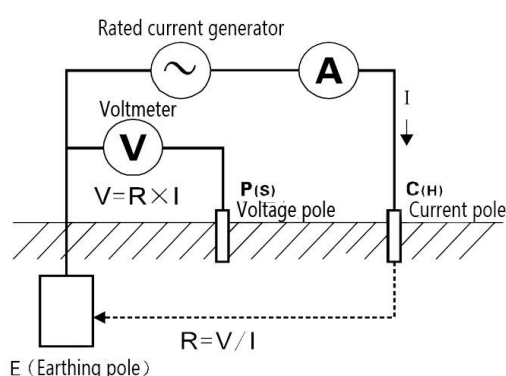

2. The electrorheological pole method is used to measure the grounding resistance value by the selective method. One of the grounding resistance values of the grounding system, at the Re1 Re2 Re3 grounding electrode and C(H) current AC current I is applied between the poles, current I_3 flowing through Re3 is measured by CT2, and Re3 connection is also measured. The potential difference V between the earth pole and the P(S) voltage pole is calculated and the grounding resistance $Re3$ is calculated according to the formula $Re3=V/I_3$. In order to ensure the accuracy of the test, the four-line method is adopted to increase the ES-assisted polarity, and the ES and E are used in the actual test. Clamped at the same point of the grounding body

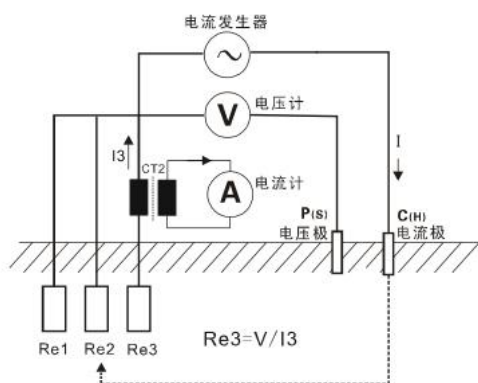

3. Double-clamp method for measuring grounding resistance (suitable for multi-independent point parallel grounding system without auxiliary pile measurement) An alternating current electromotive force V is generated by exciting clamp **CT1** and returned under the action of alternating current electromotive force V . The current I is generated in the circuit, and the feedback current I is detected by **CT2**, and the electricity is calculated according to formula $R=V/I$. Resistance value, $R = R_e + R_1//R_2//R_3//... R_{n-1}//R_n$, when $R_1//R_2//R_3//... R_{n-1}//R_n$ (multiple) The resistance value of parallel grounding points is much less than R_e , with $R \approx R_e$.

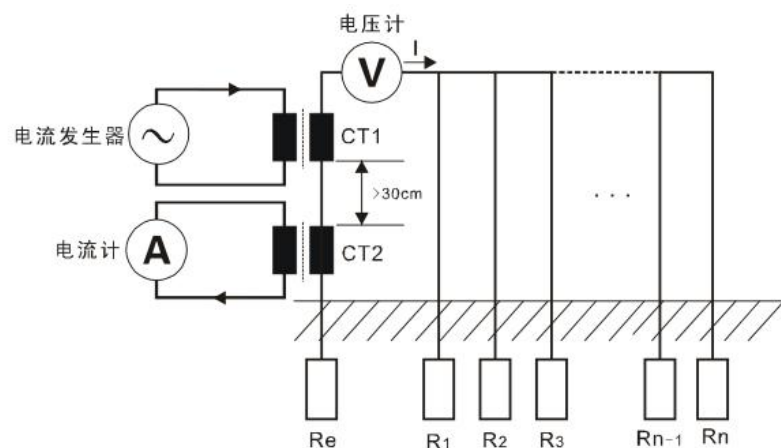

4. Soil resistivity (ρ) is measured by four-pole method (Winner method): E-grounding electrode and **C(H)** current interelectrode current A. C. Current I . Calculate the potential difference V between the **P(S)** voltage pole and the ES auxiliary pole, and divide the potential difference V by the alternating current. The resistance R of the middle two points is obtained by current I . The distance between the electrodes is a (m), and according to the formula $\rho = 2 \pi a R$ (Ω m) When the distance between **C(H) - P(S)** and **P(S) - ES** is equal (both are a) That is Winner's method. In order to calculate conveniently, please let the distance between electrodes a far greater than the depth of burial h , which should generally be satisfied. $a > 20h$, see figure below.

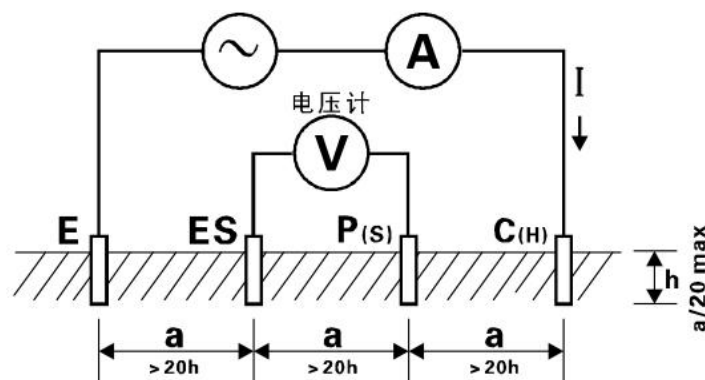

5. The rated electrorheological pole method (suitable for measuring equipotential connection) is used for testing DC resistance of two, three and four lines. Resistance test, that is to say, to calculate the potential difference V between the two ends of R by measuring the rated current I of flowing DC between the objects R . The grounding resistance R is calculated according to formula $R=V/I$. In order to ensure the accuracy of the test, the four-line method is adopted. Adding ES to assist the earth pole, ES and E are clamped at the same point of the measured object in the actual test.

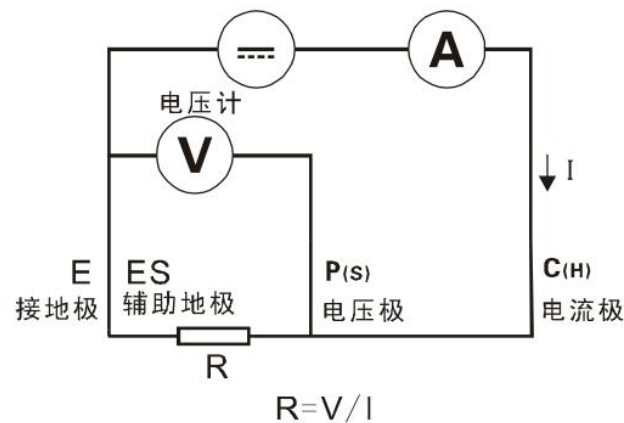

6. The working errors (**B**) of the above methods are calculated from the inherent errors (**A**) and the variation errors (**E_i**) of the instruments used.

$$B = \pm (|A| + 1.15 \times \sqrt{E_2^2 + E_3^2 + E_4^2 + E_5^2})$$

A: inherent error

E₂: changes in power supply voltage variations

E₃: variation of temperature variation

E₄: changes caused by disturbance voltage changes

E₅: changes in resistance of contact electrodes

7. The average rectification method is used to measure the leakage current of AC current.

8. The average rectification method is used to measure the grounding voltage.



VI. Operation

1. Basic Operation





Turn the **FUNCTION** function knob to realize the switch machine, and the knob indicates the "OFF" position is turned off. This instrument shuts down automatically 15 minutes after the start-up. After the automatic shut-down, the function knob will be transferred to the "OFF" position and restart.

After power on, if the LCD display battery voltage low sign "  ", indicating that the battery is insufficient, please charge the battery according to the instructions. Battery power is sufficient to ensure measurement accuracy.

After starting, press the  key to turn on or turn off the backlight. The backlight function is suitable for dim places. The default backlight is turned off every time.

After power on, the **FUNCTION** function selection knob is turned to the corresponding position, short press "AL" key can turn on or off the alarm function, long press "AL" key (about 3 seconds) to enter the alarm threshold setting, press "   " key to change the current number size, short press "AL" key to move the cursor, and long press "AL" key to save and exit. When the measurement value is greater than the critical set value while the alarm function is turned on, the instrument will flicker and display the sign of "  " **Dou-Dou-Dou-Dou** and send out the alarm sound.

In test mode, press "MEM" key to lock the current display data, display "HOLD" and "MEM" symbols, and automatically number storage, if the storage is full, the instrument shows "FULL" symbols. Then press the "MEM" button to unlock.

In test mode, press "MEM" key (more than 3 seconds) for data access, press "  " or "  " key to lookup data with step value of 1, hold "  " or "  " key to lookup data with step value of 10, and press "SET" key Check the values of **rC**, **rP** and **a**, then press "MEM" to exit when the currently data group is grounding resistance data or soil resistivity data.

If there is no stored data during the visit, LCD will display "-----" and see the top right picture.

In the data access state, press the "CLR" key to enter the data deletion, press the "CLR" key to select "NO" or "YES", select "NO" and then press the "MEM" key not to delete and return to the data access state, select "YES" and then press the "MEM" key to delete the stored data, after deletion LCD display "----". Data

deletion function is to delete all stored data at one time, after deletion can not be restored, please operate with caution.

The data stored in the instrument can be uploaded to the computer. Connect the RS232 communication line between the computer and the instrument, the instrument boots up, running data software, if the software shows that the serial port is opened and connected successfully, you can read the stored historical data, upload the computer and save.

Data software has the functions of reading, accessing, saving and printing historical data.

2. Test

Four wire precision test grounding resistance

	<p>When testing the grounding resistance, first confirm the grounding line to the ground voltage value, that is, the C (H) and E or P (S) and ES voltage value must be below 20V, if the grounding voltage is above 5V, the instrument shows NOISE symbols, at this time the grounding resistance measurement may produce errors, at this time will be measured grounding body equipment power off, so that the grounding voltage drops after Then the grounding resistance test is carried out.</p>
--	---

Four-wire test: Four-wire test can eliminate the influence of contact resistance between grounding body, auxiliary grounding rod, test clamp, instrument input interface (usually dirty or rusty) surface on the measurement. It can eliminate the influence of line resistance change on the measurement. It is better than three-wire test.

The following illustration: from the object under test, generally 5 m to 20 m interval, **P (H)**, **C (H)** auxiliary grounding rods are buried in a straight line deep into the earth, the grounding test line (black, green, yellow, red) from the instrument **E**, **ES**, **P (S)**, **C(H)** interface corresponding to the grounding electrode **E**, auxiliary voltage electrode **P (S)**, auxiliary current electrode **C (H)**.

	<p>The distance between the grounding body E and the current electrode C (H) should be at least five times the depth (h) of the grounding body under test or five times the length (d) of the electrode under test.</p>
	<p>The total grounding resistance of a complex grounding system is measured. The distance D is the distance of the maximum diagonal line of</p>

	the grounding system.
	When testing, the test lines can not be intertwined, otherwise it may affect the accuracy of the test.

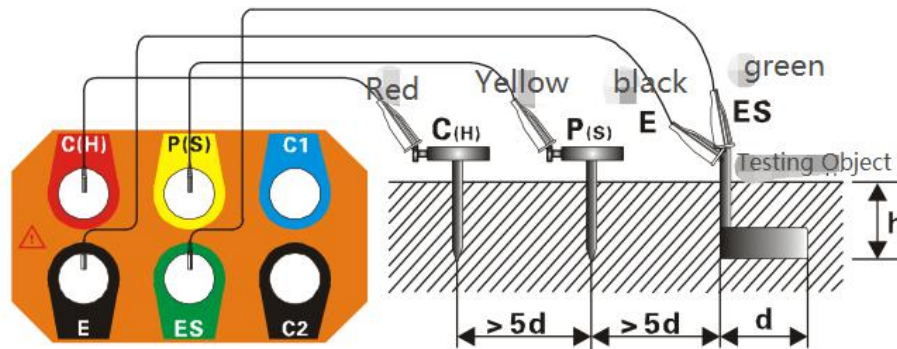

For multi-point independent grounding system or grounding system of the earth grid, users can choose longer test lines by themselves, and the electrode spacing is 5 times longer than the maximum diagonal length of the ground grid under test. As follows:

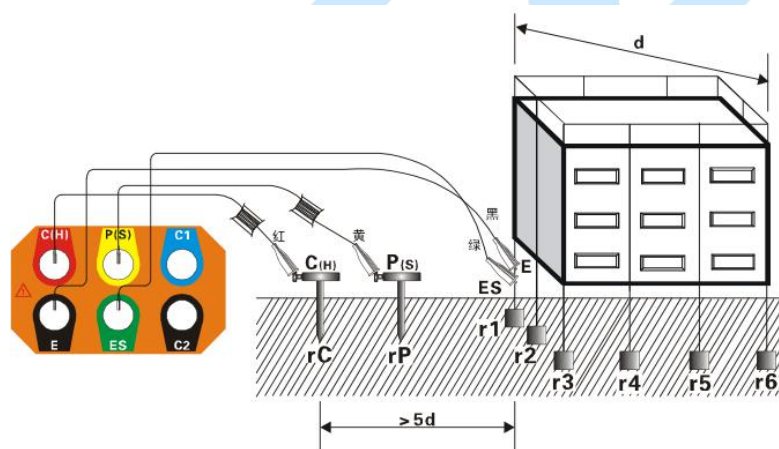

$$R = r_1 \parallel r_2 \parallel r_3 \parallel r_4 \parallel r_5 \parallel r_6 \parallel \dots \parallel r_n \quad (r_1 \dots r_n \text{ are independent grounding points})$$

R—meter reading number, the total earth resistance value of the whole grounding system.

R1...Rn—they are all independent grounding points, and each grounding wire is separately placed.

rC—auxiliary earth electrode resistance (H) of current pole C.

rP—earth resistance (S) with auxiliary voltage P.

After connecting the test line, turn the **Function** selection knob to the "**Rearth**" position to enter the grounding resistance test mode and "**test**", press the key to

start the test. During the test process, there are countdown instructions and test progress bar chart instructions. After the test, stable data will be displayed, that is, the grounding resistance value of the tested grounding body **R**.

After the test, press the "**set**" key to see the auxiliary current pole **C (H)** and auxiliary voltage pole **P** grounding resistance value **R_c**, **R_p**, **R_c**, **R_P** value display after the automatic return to show the measured grounding resistance value **R (S)**.

The following figure shows that the grounding resistance tested is 2.205 Ω , and the instrument has 8 sets of data; the grounding resistance **RC** of auxiliary current electrode **c(H)** is 0.36 k, and the grounding resistance **RP** is 0.27 K. The auxiliary voltage electrode **p(S)**.



Three wire test grounding resistance

Three-line test: as shown below, the **ES**, **E** interface of the short-circuit instrument, namely, three-line test, instrument operation and four-line test the same. Three-wire test can not eliminate the influence of wire resistance change on measurement, nor can it eliminate the influence of contact resistance change between instrument and test wire, between test wire and auxiliary grounding rod, and the oxide layer on the surface of grounding object should be removed in measurement.

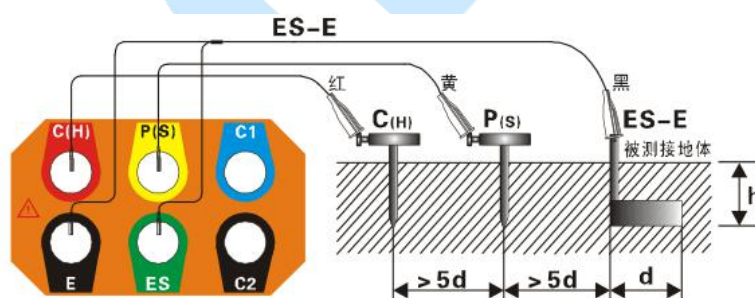

Two wire simple test grounding resistance

Two-wire test: This method is a simple measurement method without auxiliary grounding rod, using the existing grounding electrode with the smallest grounding resistance as auxiliary grounding electrode, using two simple test lines to connect (that is, **C (H)** - **P (S)** interface short connection, **E** - **ES** interface short connection).

It can replace auxiliary grounding rod **C (H)** and **P (S)** by metal pipe, fire hydrant, common grounding of commercial power system, lightning protection grounding electrode of building and so on, and pay attention to removing the oxide layer of the connection point of the selected metal auxiliary grounding body when measuring. The wiring is shown below, and the instrument operates with the four line test.

	<p>When choosing commercial power system grounding as auxiliary grounding electrode, it is necessary to confirm that it is the grounding electrode of commercial power system first, otherwise the circuit breaker may start, which is dangerous.</p> <p>The simple two-wire method is used to measure the grounding resistance, and the grounding object with small re value is selected as the auxiliary grounding electrode as far as possible, so that the meter reading is closer to the true value. Priority should be given to metal water pipes and metal fire hydrants as auxiliary grounding poles when measuring.</p>
--	--

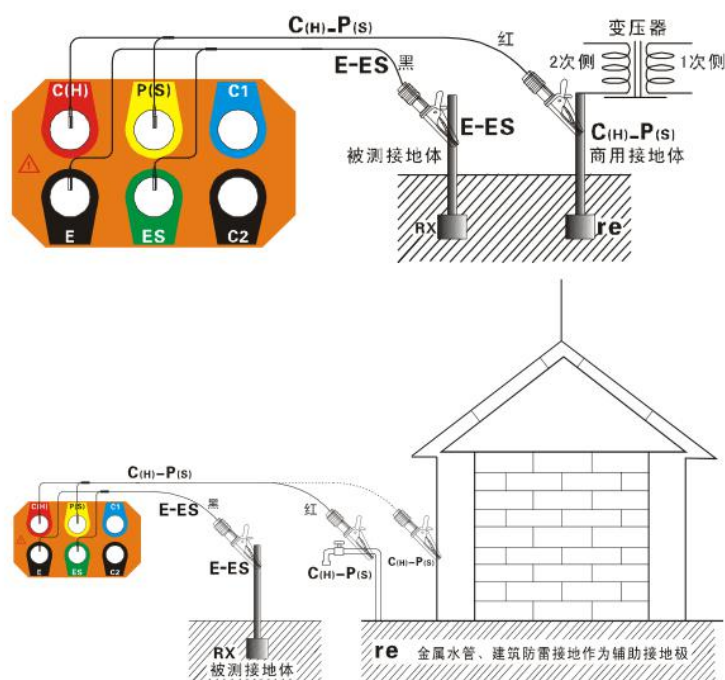

The instrument reading is the sum of the grounding resistance value of the grounding body under test and the grounding resistance value of the commercial grounding body, that is, $R = R_X + r_e$.

Among them: **R** -- for meter reading value;

R_X - the grounding resistance value of the grounded body.

re -- earthing resistance values for common grounding bodies such as commercial power systems.

Then the grounding resistance of the tested grounding body is: $R_x = R-re$.

2. Four-wire Selection Method for Grounding Resistance Measurement

	<p>When testing the grounding resistance, first confirm the grounding line to the ground voltage value, that is, the C (H) and E or P (S) and ES voltage value must be below 20V, if the grounding voltage is above 5V, the instrument shows NOISE symbols, at this time the grounding resistance measurement may produce errors, at this time will be measured grounding body equipment power off, so that the grounding voltage drops after Then the grounding resistance test is carried out.</p>
---	---

Four-wire selection method can accurately measure the grounding resistance of one grounding body without unblocking. Four-wire test can eliminate the grounding body, auxiliary grounding rod, test clamp and instrument input interface. The influence of contact resistance between surfaces on measurement can eliminate the change of line resistance. The effect is better than the three-line test.

	<p>When testing the grounding resistance, first confirm the leakage current of the grounding wire, the current of the grounding wire is in Under 2A, if the grounding wire current is greater than 100mA, the grounding resistance may be measured. Error occurs when the equipment of the grounding body is cut off to make the leakage current of the grounding wire. The grounding resistance is tested after the drop. At the same time, it ensures that the current must be measured by the selective method. The arrow direction of current clamp flows into current clamp, otherwise the grounding resistance can not be measured normally. When the table shows the symbol "⚡", it indicates that the current signal received by CT2 current clamp is too small. It should be checked whether CT2 is clamped or reversed, and whether the direction of current clamp CT2 is correct. Whether the auxiliary pile has bad contact, etc.</p>
---	---

The direction of current signal received by **CT2** is from underground to ground, inside of **CT2** handle. The direction indicated by the arrow is the direction in which the current flows.

See figure below: Starting with the object under test, the **P (S)** and **C (H)** auxiliary grounding rods are presented in a straight line, respectively. Deeply buried in the earth, ground test wires (black, green, yellow, red) from the instrument **E, ES, P (S), C (H)** The interface begins to correspond to the grounding electrode **E**, auxiliary voltage pole **P (S)**, auxiliary current pole **C (H)**. Insert the blue plug at one end of **CT2** current clamp into instrument **C1** interface, and the black plug into instrument **C2** connection. The current clamp is put into the lead of the grounding body under test. Pay attention to the direction of the current clamp. The current must be from electricity. The accuracy of measurement can be ensured only when the flow clamp inflows in front.

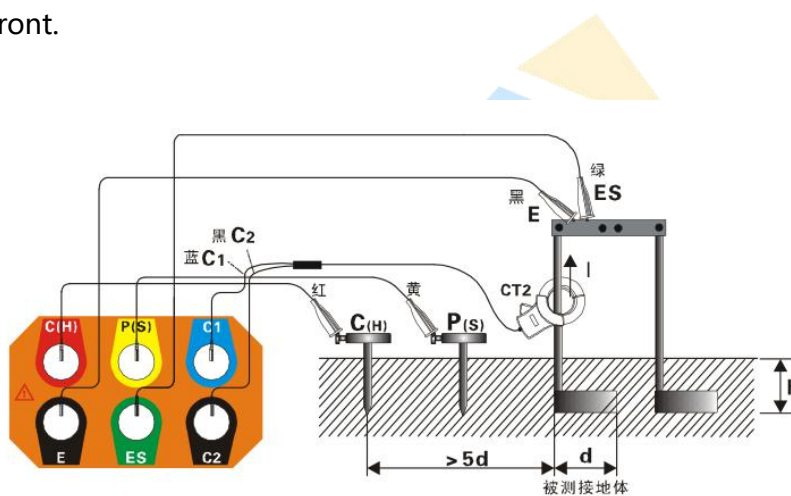

After connecting the test line, first turn the **FUNCTION** function selection knob to the " R_s " position. Enter the grounding resistance test mode, press the "TEST" button to start the test, there is a countdown in the test process. Indicate and test progress bar chart indicating that stable data is displayed after the test is completed, i.e. measured on the left side of the figure above. Grounding resistance value **R** of grounding body.

For multi-point independent grounding system or larger grounding network, 50m or longer test lines can be selected. The test results are shown as follows: the grounding resistance of **Re** measured is not affected by **r1, r2, r3, r4, etc. R5...** The influence of grounding resistance value.

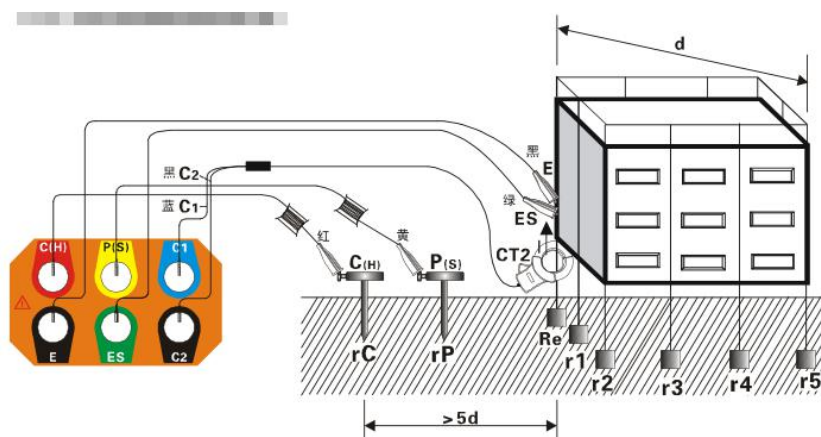

The following figure: When measuring tower grounding resistance, it can be accurately measured by four-wire selection method without unblocking. The grounding resistance value R_e of the measured tower is measured by the traditional three-wire and four-wire method without unblocking. Resistance value is the resistance value of R_e after parallel connection with R_1 , R_2 , R_3 . If R_e has a fault, and R_1 , R_2 , R_3 . It is difficult to find R_e fault point by traditional three-wire and four-wire method when the resistance of R_3 parallel connection is small. At present, it is easy to be neglected.

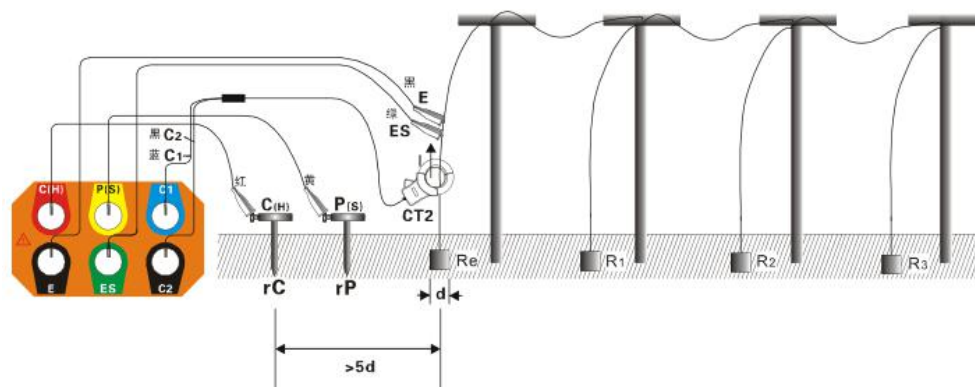

Three-wire Selection Method for Measuring Grounding Resistance

Three-line selection method test: as shown below, the ES and E interface of short-circuit instrument is three-line selection method test. Test, instrument operation is the same as four-wire selection test. Three-wire selection test can not eliminate the change of line resistance. The influence of measurement can not eliminate the contact resistance between instrument and test line, test line and auxiliary grounding rod. The influence of variation on measurement requires the removal of oxide layer on the surface of the ground body under measurement.

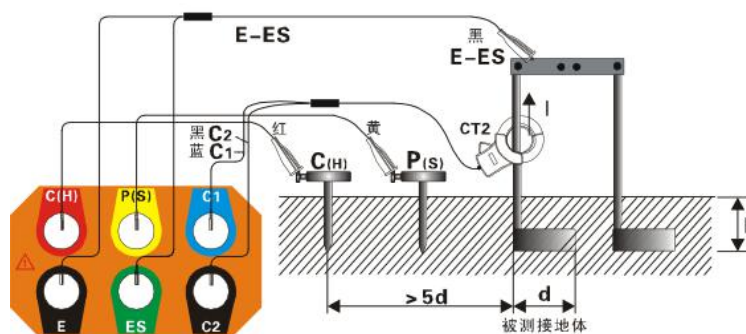

Measurement of Grounding Resistance by Double-clamp Method

The double clamp method is suitable for measuring the independent multi-point grounding system. As shown below, there is no multi-point grounding system. To measure the grounding resistance by piling, insert the red plug at one end of **CT1** current clamp into instrument **C (H)** connection. The black plug is inserted into the instrument E interface, and the blue plug at one end of **CT2** current clamp is inserted into the instrument **C1**. The black plug is inserted into the **C2** interface of the instrument, and two current clamps are clamped into the circuit under test. Pay attention to two. Current clamps should be in the same direction and keep spacing greater than 30 cm. Two current clamps should not be interchanged, otherwise they will be produced. Errors occur.

	<p>When testing the grounding resistance, first confirm the leakage current of the grounding wire, and the current of the grounding wire is greater than that of the grounding wire. At 100mA, the measurement value of grounding resistance may cause errors. At this time, the grounding resistance will be tested first. The earth body equipment is cut off, so that the leakage current of the grounding wire decreases, and then the grounding resistance is tested. At the same time, it ensures that the current must be marked by the arrow on the inside of the current clamp handle when testing by the double clamp method. To inflow current clamp, otherwise the grounding resistance can not be tested normally, when the instrument shows "⚡" When symbolizing, it indicates that the current signal received by CT2 current clamp is too small. It should be checked that the current clamp is Whether the clamp is good, the direction of CT2 current clamp is correct, the resistance of measuring circuit is too large or not. Form a loop. Current clamp spacing should be greater than 30 cm, otherwise errors will occur.</p>
---	--

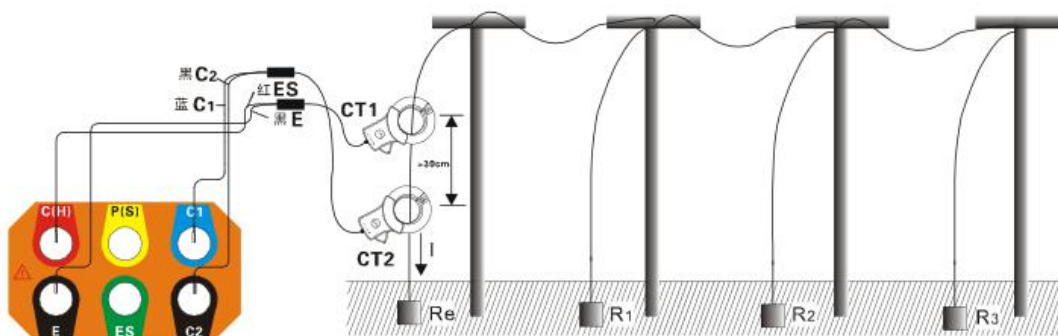

After connecting the test line, first turn the **FUNCTION** function selection knob to the “ R_E ” position. Enter the grounding resistance test mode, press the “**TEST**” button to start the test, there is a countdown in the test process. Indicating and testing progress bar chart indicating that stable data is displayed after testing, that is, the connection of the grounding body under test. The value of ground resistance $R = R_e + R_1 // R_2 // R_3$ can be approximated to $R \approx R_e$ when $R_1 // R_2 // R_3 \ll R_e$.

Soil resistivity test

Soil resistivity ρ is an important factor determining the grounding resistance of grounding object. Different properties of soil, of course, have different soil resistivity, that is, the same soil, because of temperature and water content and other differences, soil resistivity will also change significantly. Therefore, in order to have a correct basis for the design of grounding device, so that the designed grounding device can better meet the needs of practical work, it is necessary to measure the soil resistivity.

Soil resistivity was measured by the quadrupole method (**Wen Nafa**).

According to formula $\rho = 2\pi a R$ (Ωm), the soil resistivity ρ unit is Ωm .

a --- electrode spacing; resistance of soil between



R -- **P (S)** - **ES** electrode.

Quadrupole method (Winner method): Connect the test line according to the following figure, pay attention to the distance between auxiliary grounding rods and the depth of burial. **C (H)**, **P (S)**, **ES** and **E** auxiliary grounding rods are buried in the earth in a straight line and grounded. The test line (red, yellow, green and black) is connected from the **C (H)**, **P (S)**, **ES** and **E** interfaces of the instrument. The tested **C (H)**, **P (S)**, **ES**, **E** auxiliary grounding rods.

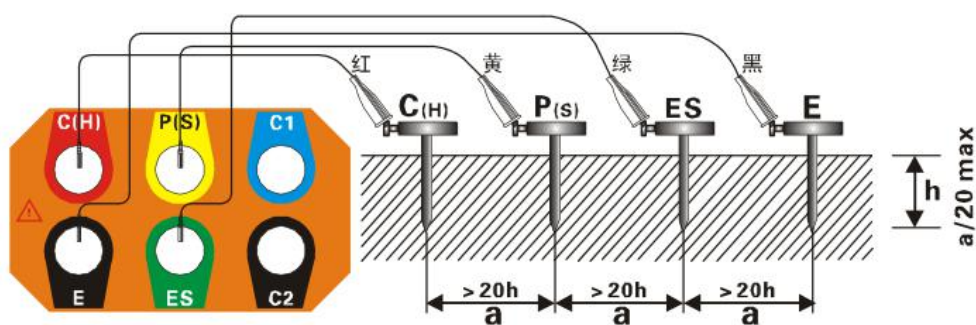
ES, **E** in a straight line into the ground, and connect the grounding test line (red, yellow, green, black) from the **C (H)**, **P (S)**, **ES**, **E** interface of the instrument to the **C (H)**, **P (S)**, **E**. **S**, **E** auxiliary grounding bar.



According to Winner method, the value of soil resistivity measured is about the distance between two grounding bars at depth **a**. The soil homogeneity can be checked by changing the value of **a**, and the suitable grounding electrode can be designed.

Assisted Grounding Bar Spacing Settings: After connecting the test line, first turn the **FUNCTION** function selection knob to the position of "**p EARTH**", enter the soil resistivity test mode, press the "**SET**" key (about 3 seconds) to enter the auxiliary grounding bar spacing settings, press the "**SET**" key to move the cursor, press the "   " key to change the currently number(a value range: 1m ~ 100m), then press **SET** key to save the set a value, and return to the soil resistivity test mode.

After setting a value, in the soil resistivity test mode, press the "**TEST**" key to start the test, and the countdown shows the test progress, after the completion of the test shows a stable soil resistivity value.

After setting **a** value, in the soil resistivity test mode, press the "**TEST**" key to start the test, andThe countdown shows the test progress and the stable soil resistivity value after completion of the test.

As shown below, the measured soil resistivity is 53.38_m. There are 157 sets of data available. Click **SET**. Key Display Ground Resistance of Auxiliary Current Pole **C(H)** **rC** and Auxiliary Voltage Pole **P(S)** **RP**, automatically returns to show measured soil resistivity **p** after display.



DC resistance test

DC resistance test is used to test equipotential connection resistance and resistance between metal components. Four-wire method Twenty-five Testing eliminates contact resistance pairs between test clips and instrument input interfaces (usually dirty or rusty) surfaces. The influence of measurement can eliminate the influence of line resistance change on measurement, which is better than the two-line method. The following figure: Measure the resistance value of the connection between the equipment and the grounding body, and put one end of the test line (black, green, yellow, red). The **E**, **ES**, **P (S)**, **C (H)** interfaces of the instrument are inserted separately, and the test lines E and ES clamp the grounding wire lead of the equipment. Out, **P (S)**, **C (H)** clamps the ground lead line near the ground end.

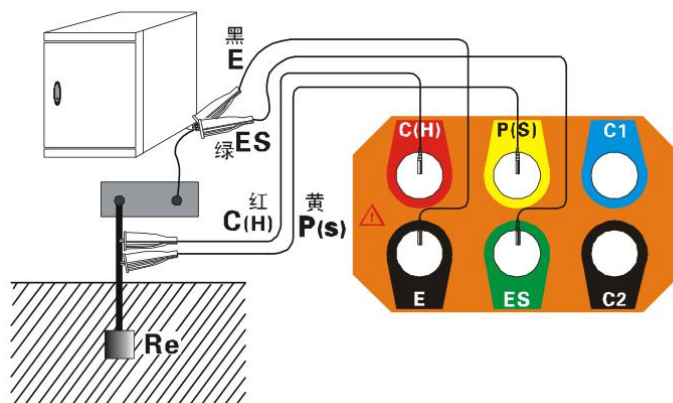

After connecting the test line, first turn the **FUNCTION** function selection knob to the " **R** " position " **R** " . Enter the DC resistance test mode, press the " **TEST** " button to start the test, there is a countdown in the test process. Indicate and test progress bar chart indication, display stable data after test, that is, equipment under test and grounding Volume equipotential junction resistance **R**.

AC current test

As shown in the figure, insert the blue plug at one end of CT2 current clamp into instrument C1 interface and the black plug into instrument C1 interface. Instrument C2 interface, the current clamp into the measured wire.

	<p>The current of the line under test should not exceed 600A. It can only be tested with current clamp, but not with current clamp. The current signal is directly connected to the instrument jack, otherwise the instrument may be damaged.</p>
	<p>When measuring the current, the CT2 current clamp will cause errors when switching current clamp is used.</p>
	<p>When measuring the load current, the current clamp holds the fire line (single), and the fire line when measuring the leakage current. Zero wires clamp together (two) or ground wires.</p>
	<p>When measuring leakage current, the interference of surrounding electromagnetic field should be avoided.</p>

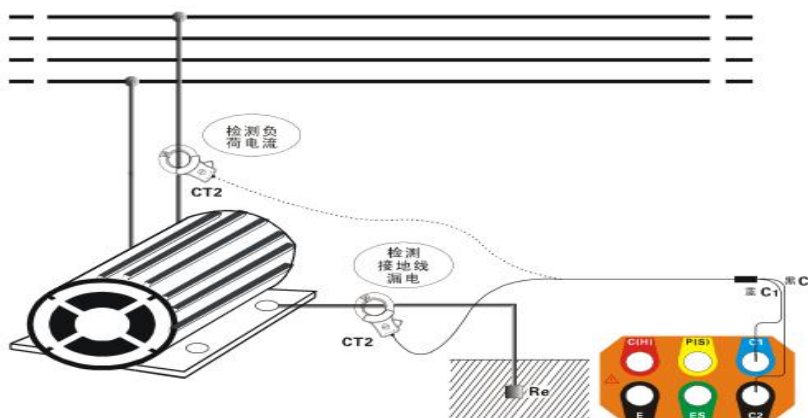

After connecting the current clamp, first turn the **FUNCTION** function selection knob to the "**I clamp**" position. In the current test mode, **LCD** displays the RMS of current directly, and the bar chart indicates the change of amplitude.

Grounding voltage test

	Requiring 1 auxiliary grounding rods for grounding voltage test.
	As long as the instrument is connected to the earth through the test line and auxiliary grounding rod, the other test lines of the instrument interface can not be connected to the L, N lines of commercial power supply, otherwise causing leakage of electricity, circuit breaker, dangerous !
	Grounding voltage test should not exceed 100V.
	It can not be used for commercial voltage test, otherwise the instrument will be damaged.

Grounding voltage: that is, when electrical equipment grounding fault occurs, the potential difference between the shell of grounding equipment, grounding wire, grounding body and zero potential point, grounding voltage is to take the earth as a reference point, the potential difference with the earth, the earth is zero potential point.

An auxiliary grounding bar should be used in the grounding voltage test, and the difference between commercial AC voltage test and auxiliary grounding bar should be noted. See the following figure: After the instrument, auxiliary grounding rod and test line are connected, switch the **FUNCTION** function conversion knob to the "**EARTH VOLTAGE**" position and start testing the grounding voltage. LCD displays the test results.

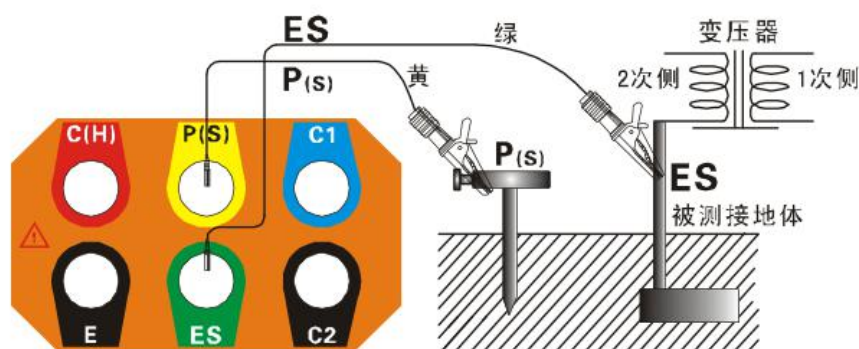

VII. Battery management



- charge the battery in time, do not use the meter for a long time, charge the battery once every 3 months.
- When charging, the indicator on the charger is bright red, full battery in bright green.
- Must use standard chargers to charge.

1. when the battery voltage is insufficient, please charge in time, charging time is about 1 hours.
2. To replace the battery, open four screws from the bottom of the toolbox, remove the instrument panel, and replace the battery. If the user is unable to replace the battery, please contact the manufacturer.
3. rotating **FUNCTION** function knob to see if it can start normally. If you can't turn on the machine, press the second step to re-operate.

VIII. Package

Instrument	1set
Tools box	1pcs
auxiliary grounding rods	4pcs
Test wire	4pcs(red 20m ; yellow 10m ; green 10m ; black20m)
Simple testing wire	2pcs(red 1.6m ; black 1.6m)
Current clamp	2pcs
Charger, Charger line	1set
Data Software(E-Edition)	1pcs
RS232 communication wire	1pcs
User manual, warranty card, qualification	1pcs

- Company is not responsible for other losses arising from use.
- The contents of this user manual can not be used as a justification for using the product for special purposes.
- The company reserves the right to modify the contents of user manuals. If there is any amendment, no further notice will be given.