

ETCR Series Earth Clamp Meter



CONTENT

I. Attention.....	1
II. Brief Introduction.....	3
III. Specification.....	5
1. Model of Series.....	5
2. Ranges and Accuracy of Measurement.....	5
3. Specifications.....	6
IV. Structure of Meter.....	7
V. Liquid Crystal Display.....	8
1. LCD Screen.....	8
2. Description of Special Symbols.....	9
3. Examples Illustrated.....	10
VI. Function Zoom Table.....	11
VII. Operating Method.....	12
1. Boot up.....	12
2. Shutdown.....	13
3. Resistance Measurement.....	13
*4. Current Measurement.....	15
5. Date Lock/Release/Storage.....	15
6. Data Access.....	16
7. Alarm Settings.....	17
8. Access to Alarm Critical Value.....	18
9. Clear Data.....	18
VIII. Measurement Principle.....	18
1. Principle of Resistance Measurement.....	18
2. Principle of Current Measurement.....	19
IX. Measurement Method of Earth Resistance.....	19
1. Multi-Point Grounding System.....	19
2. Limited Point Grounding System.....	20
3. Single-Point Grounding System.....	22
X. Field Application.....	25
XI. Matters need attention when measuring grounding resistance.....	30
XII. Bill of Loading.....	33
XIII. Parts List and Assembly Details.....	33
1. Parts List.....	33
2. Assembly Details.....	34
XIV. Trouble shooting.....	35

I. Attention

Thank you for purchasing this pincers earth tester. In order to make better use of the product, please be certain:

----To read this user manual carefully.

----To comply with the operating cautions presented in this manual.

- 1 Under any circumstances, use the Meter should pay special attention to safety.
- 2 Pay attention to the measurement range of the Meter and the using environment provided.
- 3 Pay attention to the text labeled on the panel and back plane of the Meter.
- 4 Before booting up, the trigger should be pressed for 1-2 times to ensure the jaws are well closed.
- 5 At Boot time, DO NOT press the trigger, nor clamp any wire.
- 6 Before the auto inspection is completed and the "OL Ω " symbols are showed, the measured objects cannot be clamped on.
- 7 The jaw planes contact must be maintained clean, and should not be polished with corrosive and rough materials.
- 8 Avoid any impact onto this Meter, especially the Jaw contact surface.
- 9 This Meter will have some buzzing sound in measurement process, and it is normal.

- 10 The measurement current of the wire should not exceed the upper limit of the Meter.
- 11 Please take out the batteries in the case of the Meter being idle for a long time.
- 12 The dismantling, calibration and maintenance the Meter shall be operated by the authorized staff.
- 13 If the continuing use of it would be dangerous, the Meter should be stopped using immediately, and immediately sealed for the treatment by the authorized agencies.
- 14 The contents in this user manual marked with "*" are limited to **C+**.

II. Brief Introduction

This instrument was designed by technical department of ETCR Electronic Technology Company. Its performance is mainly reflected in:

- ◆ Breakthrough in self-test the boot a long time to wait, start immediately into the test.
- ◆ Breakthrough relay self-test mode, using the most advanced processing algorithms and digital integration technology, a fully intelligent.
- ◆ Break the old product to heavy issues, more in line with characteristics of handheld devices.
- ◆ New design, panel operation with 6 buttons, better performance.
- ◆ An increase of sound and light alarm, "beep—beep--beep --" alarm sound.
- ◆ Increase the interference signal recognition indicator.
- ◆ Improved anti-jamming capability and test stability.
- ◆ Stored data: 99 Units.
- ◆ Wider range: 0.01Ω-1200Ω
- ◆ Lower power consumption: Maximum operating current not exceeding 50mA.

ETCR series of Pincers Earth Tester is widely used in the grounding resistance measurement of the power, telecommunications, meteorology, oilfield, construction and the

industrial and electrical equipment.

ETCR series of Pincers Earth Tester, in the measurement of a grounding system with loop current, does not require breaking down the grounding wire, and need no auxiliary electrode. It is safe, fast and simple in use.

ETCR series of Pincers Earth Tester can measure out the faults beyond the reach of the traditional methods, and can be applied in the occasions not in the range of the traditional methods.

ETCR series of Pincers Earth Tester can measure the integrated value of the grounding body resistance and the grounding lead resistance.

ETCR series of Pincers Earth Tester is equipped with a long jaw, as indicated in the figure below. A long jaw is particularly suitable for the occasion of grounding with the flat steel.

In addition,

C+ Pincers Earth Tester is also able to measure the leakage current and the neutral current in the grounding system.

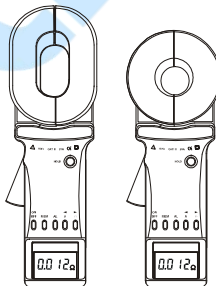

III. Specification

1. Model of Series

Model	Jaw Size (mm)	Range of Resistance (Ω)	Range of Current (A)	Storage Function	Alarm Function
ETCR2000+	65×32	0.01--1200	--	99 Units	√
ETCR2000A+	65×32	0.01--200	--	99 Units	√
ETCR2000C+	65×32	0.01--1200	0.0--20.0	99 Units	√
ETCR2100+	ϕ 32	0.01--1200	--	99 Units	√
ETCR2100A+	ϕ 32	0.01--200	--	99 Units	√
ETCR2100C+	ϕ 32	0.01--1200	0.0--20.0	99 Units	√

Note: “√” means available.

2. Ranges and Accuracy of Measurement

Mode	Range	Resolution	Accuracy
Resistance	0.010 Ω -0.099 Ω	0.001 Ω	\pm (1%+0.01 Ω)
	0.10 Ω -0.99 Ω	0.01 Ω	\pm (1%+0.01 Ω)
	1.0 Ω -49.9 Ω	0.1 Ω	\pm (1%+0.1 Ω)
	50.0 Ω -99.5 Ω	0.5 Ω	\pm (1.5%+0.5 Ω)
	100 Ω -199 Ω	1 Ω	\pm (2%+1 Ω)
	200 Ω -395 Ω	5 Ω	\pm (5%+5 Ω)
	400-590 Ω	10 Ω	\pm (10%+10 Ω)
	600 Ω -880 Ω	20 Ω	\pm (20%+20 Ω)
	900 Ω -1200 Ω	30 Ω	\pm (25%+30 Ω)
*Current (True-RMS)	0.00mA -9.00mA	0.05mA	\pm (2.5%+2mA)
	10.0mA -99.0mA	0.1mA	\pm (2.5%+10mA)
	100mA -300mA	1mA	\pm (2.5%+20mA)
	0.30A-2.99A	0.01A	\pm (2.5%+0.1A)
	3.0A-9.9A	0.1A	\pm (2.5%+0.5A)
	10.0A-20.0A	0.1 A	\pm (2.5%+1 A)

Resistance Measurement Frequency: >1KHz

Measured Current Frequency: 50Hz/60Hz

Setting Range of Resistance Alarm Critical Value: 1 Ω -199 Ω

*Setting Range of Current Alarm Critical Value: 1mA -499mA

3. Specifications

Instrument safety: IEC/EN61010-1, IEC/EN6010-2-032

Insulation: double insulation

Pollution degree: class II

Overvoltage category: CAT III 150V to ground, Max 20A

Degrees of protection:

-IP30, Group III equipment as per EN 60529 Ed 92

-IK04, as per EN 50102 Ed 95

Dimensions(L×W×H):

-Long elliptic jaw: 285mm×90mm×66mm; (11×4×3 inches)

-Round jaw: 260mm×90mm×66mm;(10×4×3 inches)

Span of Jaw: Long elliptic jaw 35mm; round jaw 32mm

Weight (including batteries): Long elliptic jaw-1160g, Round jaw-1120g

Battery type: 4 ×1.5V alkaline LR6 AA battery

Low battery indication:  is displayed

Internal consumption: <50mA

Auto Power off: after 5 minutes of idleness

Display: 4 LCD, sign, decimal point and backlight

Memory size: 99 Units of Reading

Environment (Temperature & Relative Humidity):

-Working: -10°C~55°C, 10%RH-90%RH

-Storage: -20°C ~60°C, below 70%RH

Range shift: Full range automatic shifting

External magnetic field: <40A/m

External electric field: <1V/m

Data upload interface: RS232 (Optional)

IV. Structure of Meter

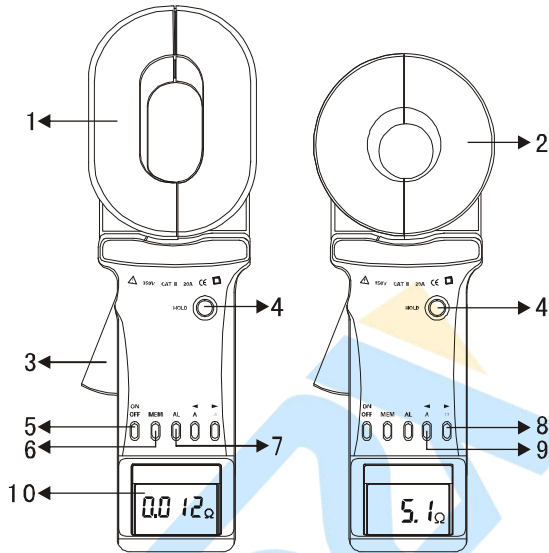

1. **Long Pincers Jaw** : 65mmx32mm
2. **Round Pincer Jaw** : $\phi 32$ mm
3. **Trigger**: to control opening and closing of jaw
4. **HOLD Key**: lock / Release display / Storage
5. **ON/OFF Key**: Boot Up / Shutdown /*Quit /Clear Data
6. **MEM Key**: Data Access / Clear Data
7. **AL Alarm Function Key**: Alarm Open / Turn Off / Alarm Critical Value Setting
8. **Resistance Measure Switch Key Ω (Right Arrow Key)**
9. ***Current Measure Switch Key A (Left Arrow Key)**
10. **Liquid Crystal Display (LCD)**

Note: "*" is limited to C+.

V. Liquid Crystal Display



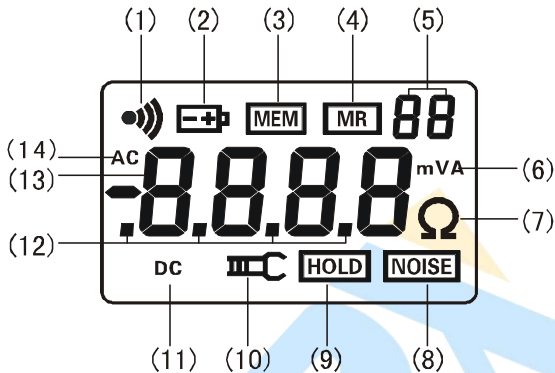



1. LCD Screen



- (1). Alarm Symbol
- (2). Symbol of low battery & voltage
- (3). Symbol of full data storage
- (4). Symbol of data access
- (5). 2-Digital No. Of Data Storage Unit
- (6). Current unit
- (7). Resistance unit
- (8). Noise signal
- (9). Data lock symbol
- (10). Symbol of an open jaw
- (11). Symbol of DC
- (12). Metrication decimal point
- (13). 4-digit LCD figures display
- (14). Symbol of AC

2. Description of Special Symbols

Note: "*" is limited to C+.

- (1).  Symbol of an open jaw: As a jaw is in the open state, the symbol shows. At this point, trigger may be artificially pressed, or the jaws have been seriously polluted, and can no longer continue to measure.
- (2). "Er" Boot error symbol, May be pressing trigger when boot or jaw has been opened.
- (3).  Symbol of low battery & voltage: when the battery voltage is lower than 5.3V, the symbol shows. At this time, it cannot guarantee accuracy of the measurements. Batteries should be replaced.
- (4). "OL Ω" symbol indicates that the measured resistance has exceeded the upper limit of the Meter.
- (5). "L0.01Ω" symbol indicates that the measured resistance has exceeded the lower limit of the Meter.
- * (6). "OL A" symbol indicates that the measured current has exceeded the upper limit of the Meter.
- (7).  Alarm symbol: when the measured value is greater than the critical value of alarm setting, the symbol flashes, and the meter issued by intermittent "beep--beep -beep--" sound.
- (8).  Symbol of full data storage: memory is full of data units of 99, and can no longer continue to store data.  symbol flashes.
- (9).  Symbol of access to data: to display in an access to data, also including the number of data.

- (10). **NOISE** signal: when the symbol flashes, in the measurement of grounding resistance at a greater interference current in the loop. At this time it cannot guarantee accuracy of the measurements.

3. Examples Illustrated

Note: "*" is limited to C+.

- | | |
|--|--|
| (1). ---Jaw is in open state, and cannot measure | |
| (2). ---Boot error instructions Er (Error) | |
| (3). ---Measured loop resistance is less than 0.01Ω | |
| (4). ---Measured loop resistance is 5.1Ω | |
| (5). ---Measured loop resistance is 2.1Ω
---Lock the current measurement value: 2.1Ω | |
| (6). ---Access to the stored data of Unit No.26
---Measured loop resistance is 0.028Ω | |
| *(7). ---Alarm function activated, the measured current exceeded | |

the critical value of alarm setting

---Low battery & voltage is displayed. At this time, it not guarantee the accuracy of the measurements

---Measured current is 8.40A

---Lock the current value displayed

---Store the current value as the data

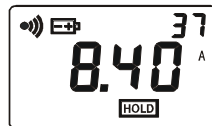

Unit No.37

(8). --- Access to the stored data unit No.8

--- Measured resistance is 30Ω

--- This data is measured in a lot of signals interference

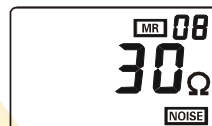

VI. Function Zoom Table

Function	Bottom
On/off/delay shutdown	ON/OFF
Lock/cancel display	HOLD
*Exit	ON/OFF
*Resistance/current measurement/data access mode	MODE
*Lock/cancel display/store/access alarm value	SET
*Set critical value/digital select/access the data have stored	MODE/SET
*Delete all the data have stored	SET+MODE

Note: “*”just for C type.

VII. Operating Method

1.Boot up

	Boot , DO NOT press the trigger, don't open jaws, nor clamp any wire
	Boot complete, show "OL Ω", then press the trigger, open jaws, clamp the measured wire
	Before booting up, the trigger should be pressed for a couple of times to ensure the jaws are well closed.
	Boot, must maintain clamp meter natural resting state, don't flip Clamp, don't be imposed outside force on the jaw, otherwise can not guarantee the accuracy of measurement

Press **ON/OFF** Key to Boot, first, automated testing LCD, show all of its symbols (Figure 1). Meanwhile the instrument auto-calibration, after boot displayed "**OL Ω**", automatically enter the resistance measurement mode (Figure 2). If there is no normal boot self-calibration, instrument will show "**Er**" symbol, said boot error. need to check the cause and reboot (Figure 3).

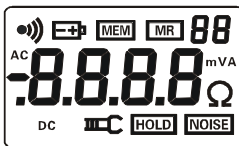

Figure 1



Figure 2

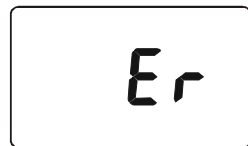

Figure 3

After Power On and Self Test if not appear "**OL Ω**",but shows a large



Figure 4

resistance (Figure 4).

However, when measured with the test ring, still gives the correct result, indicating Clamp measured only in the high-value (for example, more than 100Ω) has large errors, When measuring a small resistance retains the original Accuracy, the user can rest assured use.

2. Shutdown

Press **ON/OFF** Key to Shutdown.

5 minutes after boot, LCD display into the blinking state. To reduce battery consumption, blinking state for 30 seconds automatically shut down. In the blinking state press **ON/OFF** key to delay shutdown, Clamp continue to work.

In the **HOLD** state, need to press **HOLD** key to exit the **HOLD** state, then press **ON/OFF** key to shut down.

In setting Alarm Critical Value state, need to press the **ON/OFF** key or press the **AL** key for 3 seconds, exit Alarm Critical Value state, then press **ON/OFF** key to shut down.

3. Resistance Measurement

After the booting auto-inspection is completed, it shows "OL Ω" and will be able to proceed with resistance measurement. At this point, press the trigger and open the jaws, clamp the target loop, reading to get the resistance value.

If the user thinks it necessary, the test can be done with the ring as shown in the following figure 5. Its show value should be consistent with the normal value on the test ring (5.1Ω).

The normal value on the test ring is the

value at a temperature of 20°C.

It is normal to find the difference of numerical 1 word between the show value and the nominal value,

For instance: If the nominal value of test ring is 5.1Ω, it would be normal showing 5.0Ω or 5.2Ω.

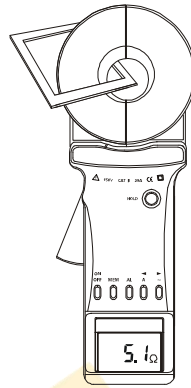

Figure 5

It shows "OL Ω", indicating that the measured resistance value exceeded the upper limit of Meter, see Figure 2.



Figure 6

It shows "L0.01Ω", indicating that the measured resistance value exceeded the lower limit of Meter, see Figure 6.

•))

Flashing display symbols , go with intermittent "beep--beep--beep--" sound, indicating the measured resistance exceeds the resistance of Alarm Critical Value.

In the **HOLD** state, need to press **HOLD** key to exit the **HOLD** state, then continue measurement.

In the **MR** state, need to press **MEM** key to exit the **MR** state, then continue to measurement.

In setting Alarm Critical Value state, need to press the **ON/OFF** key or press the **AL** key for 3 seconds, exit Alarm Critical Value state, then continue to measurement.

*In the current test mode, press **Ω** key to switch to resistance test mode.

*4. Current Measurement

After the booting auto-inspection is completed, the Meter automatically enter the resistance measurement mode. Upon showing "OL Ω", press **A** key, and the Meter enter the current measurement mode, showing "**AC 0.00mA**", see Figure 7. At this point, press the trigger and open the jaws, clamp the target wire, reading to get

the current value.

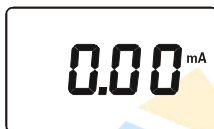

Figure 7



Figure 8

It shows "**OL A**", indicating

that the measured current value exceeded the upper limit of Meter, see Figure 8.

Flashing display symbols **•)))** , go with intermittent "beep --beep--beep--" sound, indicating the measured current exceeds the current of Alarm Critical Value.

In the **[HOLD]** state, need to press **HOLD** key to exit the **[HOLD]** state, then continue measurement.

In the **[MR]** state, need to press **MEM** key to exit the **[MR]** state, then continue to measurement.

In setting Alarm Critical Value state, need to press the **ON/OFF** key or press the **AL** key for 3 seconds, exit Alarm Critical Value state, then continue to measurement.

In the resistance test model, press **A** key to switch to current test model.

5. Date Lock/Release/Storage

In test model, press **HOLD** key to Lock currently displayed value and **[HOLD]** symbol. At the same time, this lock-values as a

set of data followed by auto-ID and store, and then press **HOLD** key to cancel the lock, **HOLD** symbol disappeared, can continue to measure. Loop operation, can store 99 sets of data. If the memory is full, blinking display **MEM** symbol.

Figure 9, Lock measured resistance 0.016Ω, at the same time as the first 01 sets of data storage.

*As indicated in Figure 10, lock the measured current 278mA, and save it as data unit No.99.

And the memory is full now.

blinking display **MEM** symbol.



Figure 9

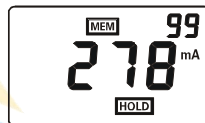

Figure 10

In the Date Access Model, press **MEM** key to exit, then can lock and storage the data.

In setting Alarm Critical Value state, need to press the **ON/OFF** key or press the **AL** key for 3 seconds, exit Alarm Critical Value state, then can lock and storage the data.

Shutdown and then boot up, don't lose stored data.

6. Data Access

Press **MEM** key to enter Data Access Model, the default display stored in the first 01 Units of data, shown in Figure 11. Then the right arrow keys, up, read the data stored, press the left arrow key,



Figure 11

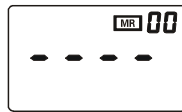

Figure 12

scroll down to the data stored. If not store data, display shown in Figure 12.

In setting Alarm Critical Value state, need to press the **ON/OFF**

key or press the **AL** key for 3 seconds, exit Alarm Critical Value state, then press **MEM** key to enter data storage model.

7. Alarm Settings

In the test model, press **AL** key to turn on or shutdown alarm function.

In test model, press **AL** key for 3 seconds, then enter to set alarm critical value function, temporality, the highest-digit flashing, first set a maximum bit, shown in Figure 13, Figure 14. Press **AL** key to switch to the low number, in the current digit flashing, press the left/right arrow keys to change the "0,1, ... 9" figures, after the number finished setting, press the **AL** key for 3 seconds to confirm the current set alarm critical value, when set the alarm function successful, opening alarm function, then automatically return to measurement mode. If the load bigger than the alarm critical, meter will be flashing an alarm symbol, also issued intermittent "beep--beep--beep--" sound.

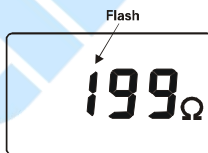

Figure 13

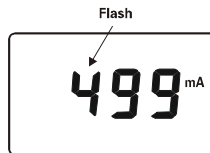

Figure 14

Setting process, press **ON/OFF** key to exit Alarm Critical Value setting function, return to measurement status, does not change the previous settings.

In data access model, press **MEM** key to exit, then setting Alarm Critical Value.

8. Access to Alarm Critical Value

Press **AL** key to enter the mode of resistance or current measurement. Press down **AL** key for 3 sec, you can access to check the alarm critical value, which would flashes in high-digit. The value accessed was set in the last time. And again press down **AL** key for 3 sec or **ON/OFF** key to quit from the access state and return to the measuring state.

As indicated in Figure 15, the alarm critical value of resistance set in the last time is 20 Ω .

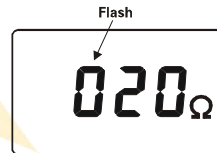

Figure 15

9. Clear Data

In the data access model, press **MEM+ON/OFF**, automatism clear all the stored data. After clearing display show in Figure 12. The data can't be restore after clear.

Note: "*" is limited to C+.

VIII. Measurement Principle

1. Principle of Resistance Measurement

The basic principle of **ETCR** in the measurement of resistance is to measure the loop resistance, as shown in the figure below. The jaw part of the Meter is comprised of voltage coil and current coil. The voltage coil provides excitation signal, and will induce a potential E on the measured loop. Under the effects of the potential E , the

current I can generate on the measured loop. The Meter will measure E & I , and the measured resistance R can be obtained by the following formula.

$$R = \frac{E}{I}$$

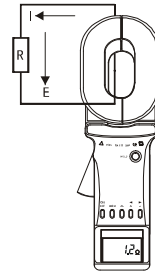

2. Principle of Current Measurement

The basic principle of **C+** in the measurement of current is the same with that of the measurement of resistance, as shown in the figure below. The AC current on the measured wire, through the current magnetic loop and coil, can generate a induction current I_1 ; The Meter will measure I_1 , and the measured current I can be obtained by the following formula.

$$I = n \cdot I_1$$

Where: n is the turn ratio of the secondary side vs. primary side.

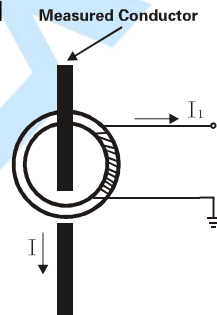

IX. Measurement Method of Earth Resistance

1. Multi-Point Grounding System

As for the multi-point grounding system (such as electricity transmission tower grounding system, grounding cable communications systems, certain buildings, etc.), They usually pass the overhead ground wire (cable shielding layer) connected

to form a grounding system.

As the Meter is in the above measurement, its equivalent electric circuit is shown in the figure below:

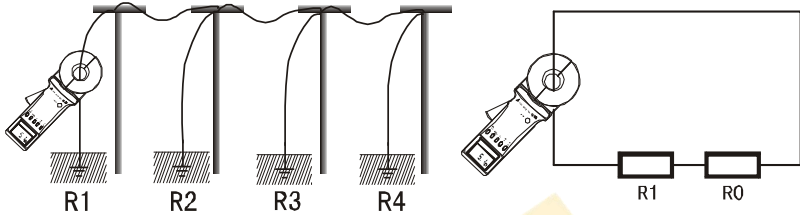

Where: R_1 is the target grounding resistance.

R_0 is the equivalent resistance of the other entire tower grounding resistances paralleled.

Although strictly on the theoretical grounding, because of the existence of so-called "mutual resistance", R_0 is not the usual parallel value in the sense of electrical engineering (slightly higher than its IEC parallel output value). But because a tower-grounding hemisphere was much smaller than the distance between the towers, and with a great number of locations after all, R_0 is much smaller than R_1 . Therefore, it can be justified to assume $R_0=0$ from an engineering perspective. In this way, the resistance we measured should be R_1 .

Times of comparing tests in different environments and different occasions with the traditional method proved that the above assumption is entirely reasonable.

2. Limited Point Grounding System

This is also quite common. For example, in some towers, five

towers are linked with each other through overhead ground wire; Besides, the grounding of some of the buildings is not an independent grounding grid, but several grounding bodies connected with each other through the wire.

Under such circumstances, the above R_0 regarded as 0, will yield more error on the results of the measurement.

Due to the same reasons mentioned above, we may ignore the impact of the mutual resistance; and the equivalent resistance of the grounding resistance paralleled is calculated by the usual sense. Thus, for the grounding system of N (N is smaller, but larger than 2) grounding bodies, it can offer N equations:

$$R_1 + \frac{1}{\frac{1}{R_2} + \frac{1}{R_3} + \dots + \frac{1}{R_N}} = R_{1T}$$

$$R_2 + \frac{1}{\frac{1}{R_1} + \frac{1}{R_3} + \dots + \frac{1}{R_N}} = R_{2T}$$

$$\vdots$$

$$\vdots$$

$$R_N + \frac{1}{\frac{1}{R_1} + \frac{1}{R_2} + \dots + \frac{1}{R_{(N-1)}}} = R_{NT}$$

Where: R_1 、 R_2 、..... R_N are grounding resistances of N grounding bodies.

R_{1T} 、 R_{2T} 、..... R_{NT} are the resistances measured with the Meter in the different grounding branches.

It is nonlinear equations with N unknown numbers and N equations. It indeed has a definite solution, but it is very difficult to solve the issue artificially, even impossible when N is larger.

Therefore, you're expected to buy the Limited-Point Grounding System Solution software produced by this Company. Users can use the office computer or notebook computer to carry out solutions.

In principle, in addition to ignoring the mutual resistance, this method does not have the measurement error caused by neglecting R_0 .

However, users need to pay attention to that: in response to the number of the grounding bodies mutually linked in your grounding system, it is necessary to measure the same number of the testing values for calculating of the program, not more or less. And the program would output the same number of grounding resistance values.

3. Single-Point Grounding System

From the measuring principle, **ETCR** series Meter can only measure the loop resistance, and the single-point grounding is not measured. However, users will be able to use a testing line very near to the earth electrode of the grounding system to artificially create a loop for testing. The following presented is two kinds of methods for the single-point grounding measurement by use of the Meter. These two methods can be applied to the occasions beyond

the reach of the traditional voltage-current testing methods.

(1).Two-Point Method

As shown in the figure below, in the vicinity of the measured grounding body R_A , find an independent grounding body of better grounding state R_B (for example, near a water pipe or a building). R_A and R_B line will connect to each other using a single testing line.

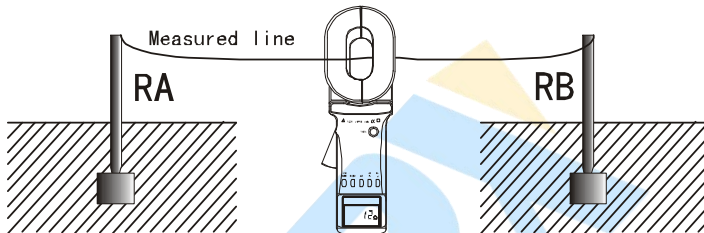

As the resistance value measured by the Meter is the value of the series resistance from the testing line and two grounding resistances.

$$R_T = R_A + R_B + R_L$$

Where: R_T is the resistance value measured with the Meter.

R_L is the resistance value of the testing line. Meter can measure out the resistance value by connecting the test lines with both ends.

So, if the measurement value of the Meter is smaller than the allowable value of the grounding resistance, then the two grounding bodies are qualified for grounding resistance.

(2) Three-Point Method

As shown in the figure below, in the vicinity of the measured grounding body R_A , find two independent grounding bodies of

better grounding state R_B and R_C .

First, link R_A and R_B with a test line; use the Meter to get the first reading R_1 .

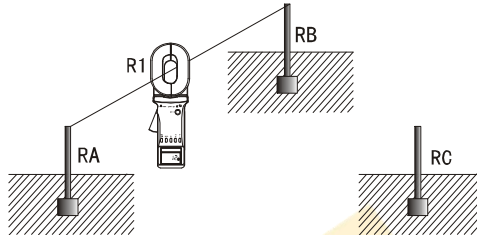

Second, have R_B and R_C linked up, as shown in the following figure. Use the Meter to get the second reading R_2 .

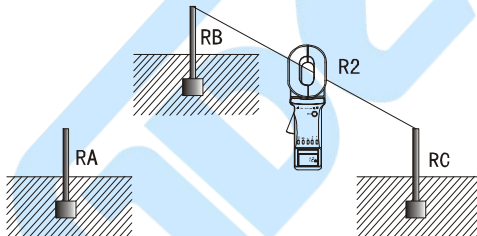

Third, have R_C and R_A linked up, as shown in the following figure. Use the Meter to get the third reading R_3 .

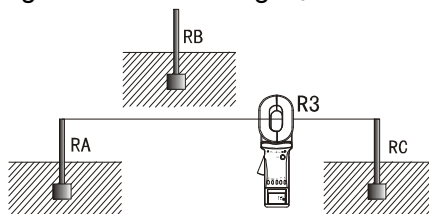

In the above three steps, the reading measured in each step is the value of the two series grounding resistance. In this way, we can

easily calculate the value of each grounding resistance:

$$\text{From: } R1=RA+RB \quad R2=RB+RC \quad R3=RC+RA$$

$$\text{We get: } RA= (R1+R3-R2) \div 2$$

This is the grounding resistance value of the grounding body R_A . To facilitate the memory of the above formula, these three grounding bodies scan be viewed as a triangle; then the measured resistance is equivalent to the value of the resistance values of the adjacent edges plus or minus resistance value of the opposite sides, and divided by 2.

As the reference points, the grounding resistance values of the other two grounding bodies are:

$$RB=R1-RA$$

$$RC=R3-RA$$

X. Field Application

1. Application in power system

(1).The measurement of grounding resistance of the tower of transmission line

Normally, the tower of transmission line connect to the earth to form multi point grounding system, use ETCR series clamp meter to clamp the grounding line, can measure the grounding resistance of the branch circuit.

(2)The measurement of neutral point of transformer

There are two situations for transformer to connect the grounding line: iterative earth to form multi point grounding resistance; single point grounding measurement for single point grounding.

When measuring, if the meter shows “L 0.01Ω” may because there are two or more grounding line of tower or transformer connected underground. At this time, should release the redundant grounding line and just remain one.

(3)The application in power station, power substation

ETCR series clamp meter can use to test the situation of contact and connect of circuit. With the help of one test line, can be used to test the connect situation of equipment in station and the grounding system. Single point grounding measurement is allowed for the measurement of grounding resistance.

2. Application in telecommunications system

(1) The measurement of the grounding resistance of machine room in the building

The machine room of telecommunication system normally in the upper deck of the building, and it hard to use the megohm meter to measure. However, it is very convenient to for ETCR. Connect the fire hydrant and the pole being measured by one testing line, then use the meter test the testing line.

The value of meter=resistance of machine room + the resistance of testing line + the grounding resistance of fire hydrant. If the grounding resistance of fire hydrant is very small, then: the grounding resistance of machine room≈value of meter-resistance of testing line

(2)The measurement of grounding resistance of machine room and the launch tower

It normally form two point grounding system When machine room and launch tower connect to ground, as show below:

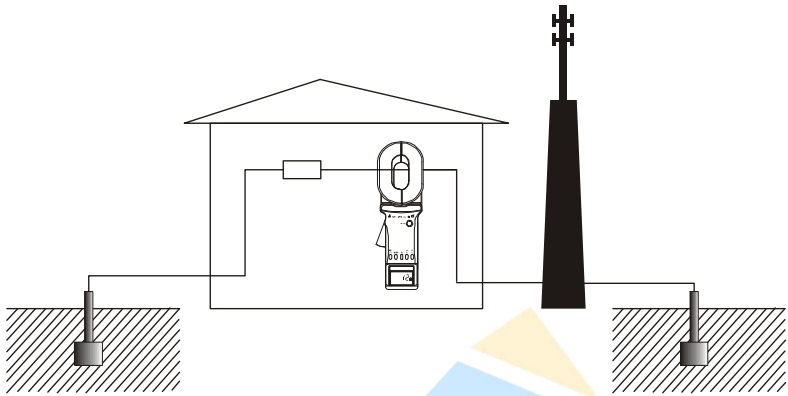

If the value of meter is lower than the allowable value of grounding resistance, then the grounding resistance of machine room and the launch tower is valid. If the value is greater than allowable value, please measure by single point grounding method.

3. Application in lightning protection system of building

If the grounding pole of the buildings is independent with each other, the measurement of grounding resistance of each grounding pole as below:

Lightning protection overhead lines

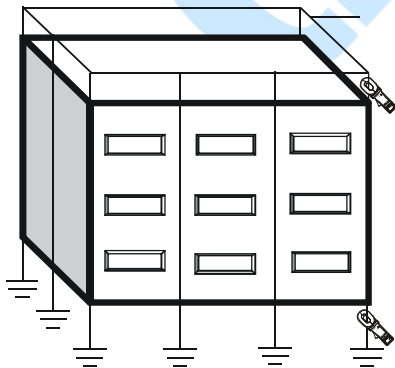

4. Application in gas station grounding system

In the environment where full of explosive gas, such as gas station, oil field, oil sink have to use explosion proof type.

Base on JJF2-2003<<Grounding Type Antistatic Device Test Specification>>, gas station mainly need to test the grounding resistance and connect resistance of the facility shows below

The meter has to obey the requirement of GB3836-2000<<Electrical Equipments Used in Explosive Gas Environment>>

No.	Item	Technical Specification
1	Grounding resistance of oil tank	$\leq 10\Omega$
2	Grounding resistance of load or unload place	$\leq 10\Omega$
3	Grounding resistance of tanker	$\leq 4\Omega$
4	Connect resistance of transport flexible piper of tanker	$\leq 5\Omega$

B type has already pass the authentication of anti-explosion, the symbol is Exia II BT3. The anti-explosion qualified number is: CE082010. It can be used in the environment relevant to flammable and combustible.

(1) The measurement of grounding resistance of tanker and upload and load place

Auxiliary grounding pole

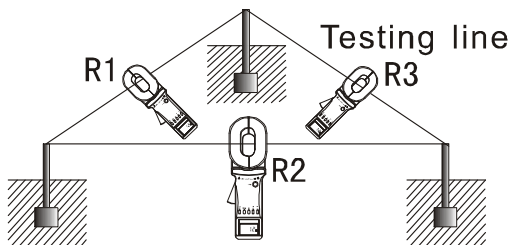

Tanker grounding pole A Grounding pole C of
-28- upload and load place

As show above, in system of gas station, oil tank grounding pole A connect with tanker, the grounding pole C of load and upload position is a independent grounding pole. Find a independent grounding pole as an auxiliary grounding pole B (like the water piper), then base on Three point method to measurement R_1 , R_2 and R_3 .

The grounding resistance of oil tank: $R_A = (R_1 + R_2 + R_3) / 2$

The grounding resistance of load and upload place:
 $R_C = R_2 - R_A$

The grounding resistance of auxiliary grounding pole:
 $R_B = R_1 - R_A$

NOTE: Cannot connect BC and AC by wires when measuring R_1 ; the same as R_2 , R_3 .

- (2) The measurement of grounding resistance of tanker

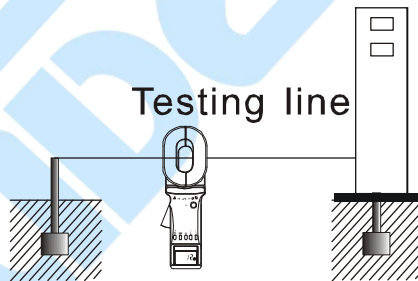

Grounding pole C of
upload and load place

As shows above, find a grounding pole which is independent with tanker, like the grounding pole of upload and load place. Connect these two points by testing line, read the value of R_T by meter. Then can calculate the grounding resistance of tanker: $R = R_T - R_C$

NOTE: R_T is the value of meter; R_C is the grounding

resistance of upload and load place.

- (3).The measurement of connect resistance of oil transmission piper of tanker

Fuel truck nozzle

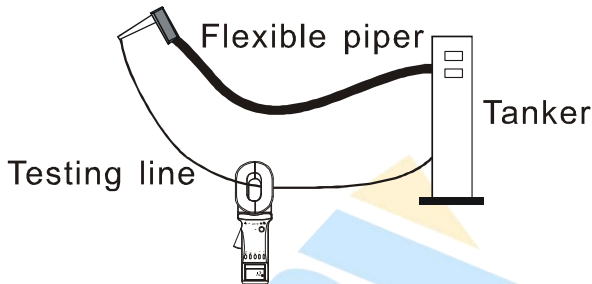

Connect Fuel truck nozzle and tanker by one testing line. Read R_T by meter, then can figure out: the connect resistance of oil transmission piper of tanker: $R=R_T-R_L$

NOTE: R_T is the resistance meter measured; R_L is the resistance of testing line.

XI. Matters need attention when measuring grounding resistance

1. Users may sometimes compare ETCR with voltage-current method of traditional, and a big different appeal; to solve the situation, users should pay attention to the problem mention below.

(1).whether the grounding body which being measured is disconnect with earth system when use traditional way like voltage-current method. If not, then the value is a parallel result of all the grounding body.

It is useless to measure the parallel result of all the grounding

body, because the aim why we measure the grounding resistance is compare it with a allowable value which is stipulated by relevant standards, to justice whether the grounding resistance is up to standard.

For example: the grounding resistance allowable value stipulated in GB50061-97 “Design standard of overhead power line with the voltage of 66KV and below” is especially for “each tower”. The specification of the standard says that: “grounding resistance of each towers, is a value when the grounding body and the grounding line is separated. If the grounding body doesn’t separate with grounding line, then the grounding resistance be measured is the parallel result of several tower.”

This standard is very specific.

Like what have mention before, the value measured by ETCR series clamp meter is the grounding resistance of each branch, if the connection of grounding line is good, it is the grounding resistance of one grounding body.

Obviously, in this condition, compare the result which measured by traditional voltage-current method with the result measured by ETCR series clamp meter doesn’t make any sense. Because what have been measured is different, the big different of the result is make sense.

(2).The grounding resistance measured by ETCR series clamp meter is comprehensive resistance of grounding branch. It includes the contact resistance of the public grounding line of this branch, lead line resistance and grounding body resistance. Under the condition of disconnect with grounding line, measured by voltage-current, the value is just for grounding resistance.

Obviously, the former one is larger than the latter one. The contact resistance of branch and public grounding line is what makes them different.

What need to specify is the grounding resistance should include the resistance of lead line which is stipulated by the

national standard. Terminology in DL/T621-1997 “The grounding of AC electric” stipulated as: the grounding resistance of grounding device is the total of the resistance to the ground of grounding pole or natural grounding electrodes and the resistance of grounding line.”

This kind of stipulate is specific. Because the resistance of lead line and the grounding resistance of grounding body is equal for lightning protection.

2. Selection of measurement point

In some grounding system, like the picture show below, should chose a correct point for measurement, or will get different result

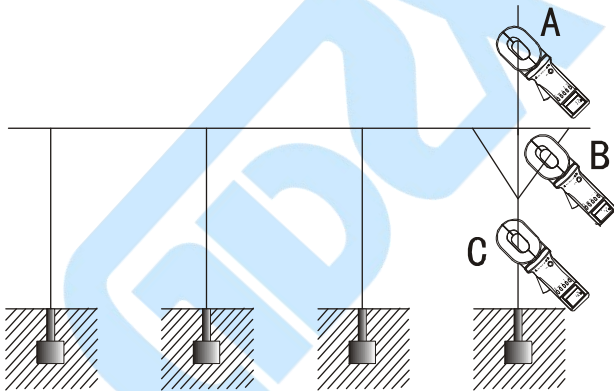

When measuring at A point, the branch doesn't form a circuit, the meter shows “OL Ω”, then should change the measuring point.

When measuring at B point, the branch being measured is the circuit of metallic conductor, the meter shows “L 0.01Ω” or the value of resistance of metallic circuit, and the value is very small

When measuring at C point, the value being measured is grounding resistance of the branch.

XII. Bill of Loading

Earth Tester	1 piece
Test Loop	1 piece
Carrying Case	1 piece
User's Manual	1 piece

XIII. Parts List and Assembly Details

1. Parts List

NO.	NAME	Part	Quantity/PCS	Remark
1	Screws of battery cover	DS01	1	M3X8
2	AA alkaline batteries	DS02	4	
3	Battery cover	DS03	1	
4	Upper shell	DS04	1	
5	Subjacent shell	DS 05	1	
6	Tension spring	DS 06	2	
7	Clamp	DS 07	1	
8	LCD	DS 08	1	
9	HOLD key	DS09	1	
10	LCD cover	DS10	1	
11	PCB	DS11	1	
12	Connect screws of shells	DS12	3	ST2.9X10

13	Clamp screws	DS13	2	ST2.9X25
14	Shaft	DS14	1	
15	Push button	DS15	5	
16	Screws for PCB fix	DS16	2	ST2.2X6
17	Screws for LCD fix	DS17	2	ST2.2X6

2. Assembly Details

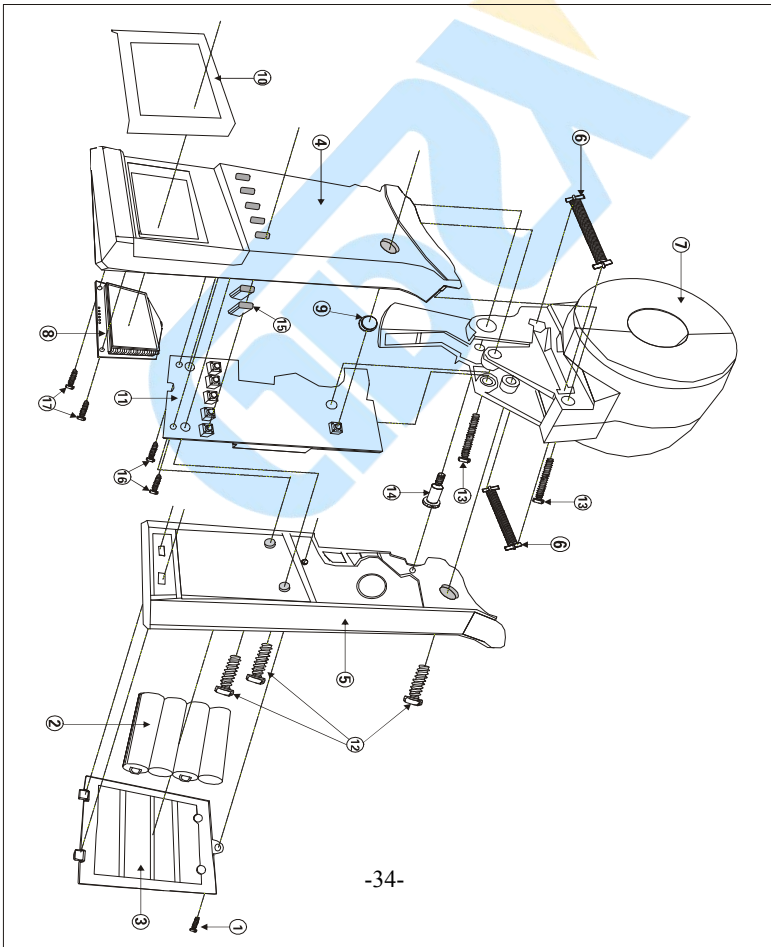

XIV. Trouble shooting

Symptoms	Possible Causes	Remedies
The instrument cannot be buttoned on.	No batteries.	Set the batteries.
	Faulty battery polarity	Install batteries in correct polarity.
	Insufficient capacity of battery	Replace the batteries.
	Poor contact of battery contacts	Replace the battery contacts.
	Wrong battery type	Replace with right type.
	A break in a battery harness	Make a continuity test of test lead. If there is no continuity, replace the battery harness.
	Departure of the ON/OFF button	Re-assemble the button.
	Poor contact of power plug	Re-plug or replace a plug.
	Defect of circuit component	Defect of PCB; when current consumption is about 100mA or more at 6V of battery voltage. Replace the PCB.
Indicating ERROR (Display "Err", big error results or results unstable)	Insufficient capacity of battery	Replace the batteries.
	Contact surface of jaw is polluted by dust, oil etc.	Clean the surface.
	Poor enclose of jaw	Trigger the clamp several times and then re-boot.
	Defect of circuit component	Replace the PCB.
	Measure in wrong steps	Study the manual and follow it.
Incapable measurement of resistance	Insufficient capacity of battery	Replace the battery when "Low battery" mark is displayed on the LCD.
	Poor enclose of jaw, indicating "jaw-open" symbol on LCD	Trigger the clamp several times and then re-boot.
	Contact surface of jaw is polluted by dust, oil etc.	Clean the surface.
	Without self-calibration before test	Re-boot follow the manual, conduct measurement after self-calibration finished.
	Defect of circuit component	Check above points first. If there is no problem, replace the PCB, and do re-adjustment.

Symptoms	Possible Causes	Remedies
LCD Indication error (chip of segment, arithmetic point, unit and so on)	Poor contact of LCD connection wire	Re-plug the LCD connect plug or replace the plug.
	Defect of LCD	Replace the LCD.
	Insufficient capacity of battery	Replace the batteries.
	Defect of circuit component	Replace the PCB.
Incapable to hold reading	HOLD button Depart from the position	Re- assemble the button.
	Defect of circuit component	Replace the PCB.